



POWERBRIDGE

2kVA Online Uninterruptible Power Supply



Astrodyne TDI's uninterruptible power provides high reliability solutions in critical locations such as laboratories, surgical suites, industrial process equipment, and military systems. The new PowerBridge™ AC UPS system provides backup power for demanding applications while facility emergency power ramps up. With an output rating of 2000VA continuous, along with battery capacity for >2 minutes at full rated power, PowerBridge™ provides a cost-effective solution to assure continuous operation of mission-critical equipment.

MAIN CHARACTERISTICS:

- 2 MOPP/ 2 MOOP
 - **Eliminates the need for external isolation**
- On-Line UPS
 - Continuous AC Output NO GLITCHES
- 2kW Output Power
- Embedded Lithium Ion Battery - Field Replaceable
- 120W-Hr High Rate LiFePO4

BENEFITS

High Reliability for Critical Applications

Astrodyne TDI's comprehensive reliability assurance processes, including design to the rigorous requirements of NAVSO P3641A, HALT, DFMEA and our unique Highly Accelerated Stress Screening (HASS) on 100% of production units, assure the ultimate in unit reliability and performance.

High Power

2kVA Output Power in a 2U high, 19" rack space
Run time > 2 minutes at 2kVA, 5 minutes at 1kVA

FEATURES

Connections

- AC Input: Panel mount IEC 60320, C14
- AC Output: (4) IEC 60320 C13 duplex outlets
- Remote Control: Ethernet (UPS/SNMP) RJ45
- Equipotential Ground Stud

Rear Panel Circuit Breakers

- Input Circuit Breaker
- (4) Output Circuit Breakers

Front Panel Indicators:

- AC Input Status
- AC Output Status
- Battery Status
- AC Output Powered by Battery

Battery Chemistry

Utilizes Lithium-Ion Iron Phosphate battery technology and provides advanced features such as individual cell monitoring and temperature compensation, providing battery life up to 10 years.



www.AstrodyneTDI.com | +1 908-850-5088

© Copyright 2019, Astrodyne, Inc (and it's affiliates, d/b/a Astrodyne TDI)

This document is believed to be correct at the time of publication and Astrodyne, Inc accepts no responsibility for consequences from printing errors or inaccuracies. Specifications are subject to change without notice.

POWERBRIDGE

2kVA Online Uninterruptible Power Supply

MODEL NUMBER	PART NUMBER	DESCRIPTION
--------------	-------------	-------------

SPS6015-LF	T100108558-00-LF	UPS, 2kVA, 4X120VAC
------------	------------------	---------------------

*For other options please contact the factory

PARAMETER	POWERNODE
-----------	-----------

Input AC	90-264VAC
----------	-----------

AC Frequency	47-63Hz
--------------	---------

Input Current	16A for 120VAC at 1200W output power 12.4A for 208VAC at 2000W output power
---------------	--

Power Factor	>.97
--------------	------

Output Voltage	120VAC/60Hz pure sine wave
----------------	----------------------------

Output Power	1600VA Continuous when operating from 90-132VAC Input 2000VA Continuous when operating from 180-264VAC Input 150% of normal peak rating for up to 10 seconds
--------------	--

Efficiency	>85%
------------	------

Battery Rating	120W-hr
----------------	---------

Charge Time	< 2hrs
-------------	--------

Protection Features	Recessed front panel switch enables or disables AC Output Rear panel Circuit Breaker for input power line.
---------------------	---

Visual Indicators	Front panel LED's indicate AC Input, AC OUT On-Line, FAULT and BAT STATUS
-------------------	---

Operating Temperature	-10 to +50°C
-----------------------	--------------

Storage/Transportation	-40 to +85°C
------------------------	--------------

Humidity	0% to 95% non-condensing
----------	--------------------------

Harmonics	meets EN61000-3-2 Electromagnetic compatibility, Class A
-----------	--

Connections	AC Input: Panel mount IEC 60320, C14 AC Output: 4 x IEC60320 C13 duplex outlets Ethernet – RJ45 on Rear Panel Equipotential Ground Stud on Rear Panel
-------------	--

EMC	Radiated and conducted emissions meet FCC Part 15, Subpart A class A, and EN55022, Class A
-----	--

Dimensions (inches)	17.5" x 16" x 3.46" 25lbs
---------------------	------------------------------

Safety	UL/IEC 60601-1 (3.1 Ed), EMC IEC60601-1-2 4 th Edition UL1778 (Uninterruptible Power Systems) Isolation input-output: 3kV (2MOPP)
--------	--

Cooling	Forced-air-cooled
---------	-------------------

Warranty	1 Year
----------	--------

Astrodyne TDI
Now you have power.

www.AstrodyneTDI.com | +1 908-850-5088

© Copyright 2020, Astrodyne, Inc
(and it's affiliates, d/b/a Astrodyne TDI)

This document is believed to be correct at the time of publication and Astrodyne, Inc accepts no responsibility for consequences from printing errors or inaccuracies. Specifications are subject to change without notice.



POWERBRIDGE

2kVA Online Uninterruptible Power Supply

Module Outline:

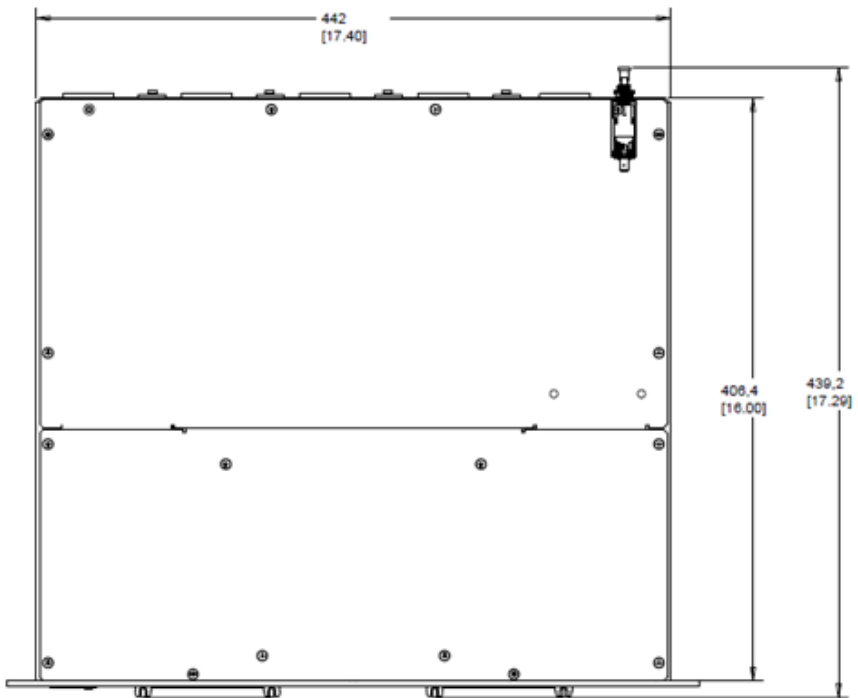
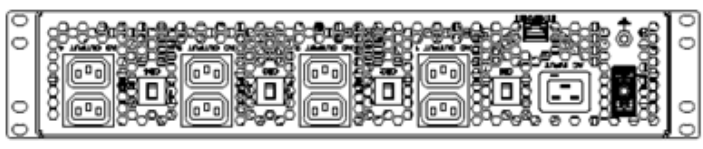

SCALE 0.500

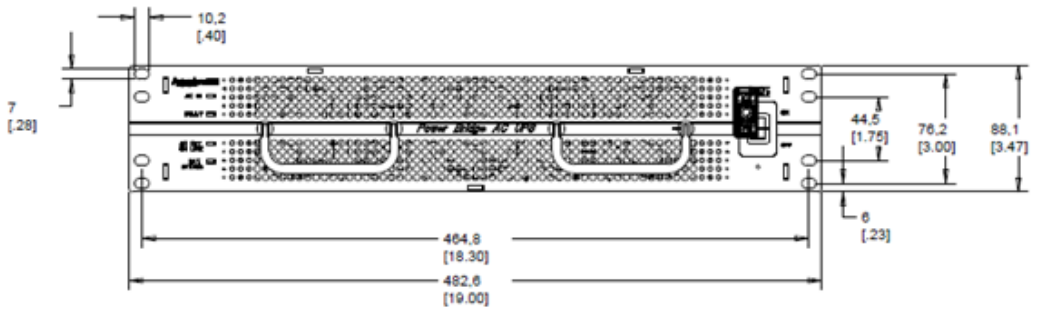
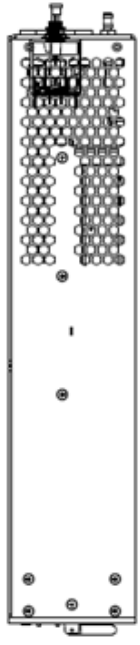

POWERBRIDGE

2kVA Online Uninterruptible Power Supply

Diagram:

OFF-LINE UNINTERRUPTED POWER SUPPLY

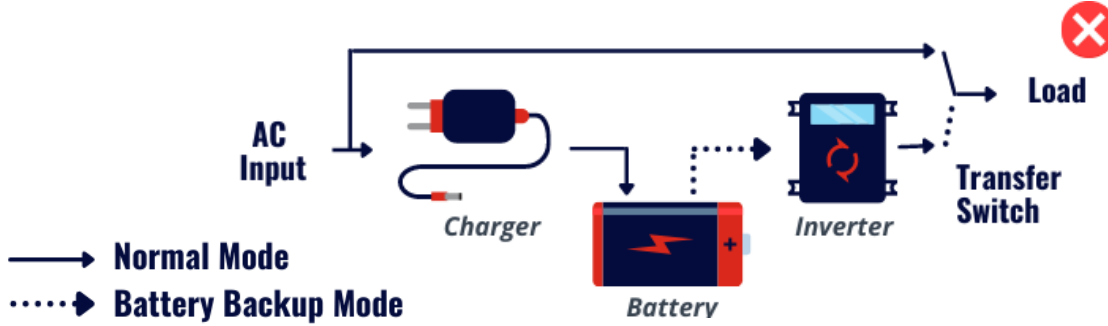

DON'T GLITCH

ASTRODYNE TDI'S ON-LINE UNINTERRUPTIBLE POWER SUPPLY

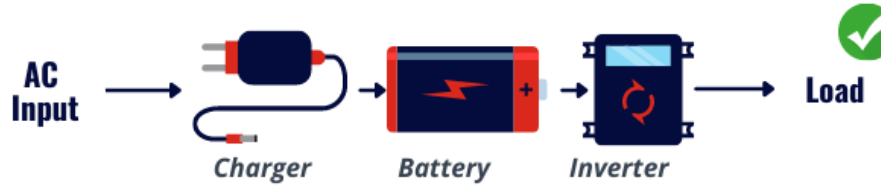

Run Time:

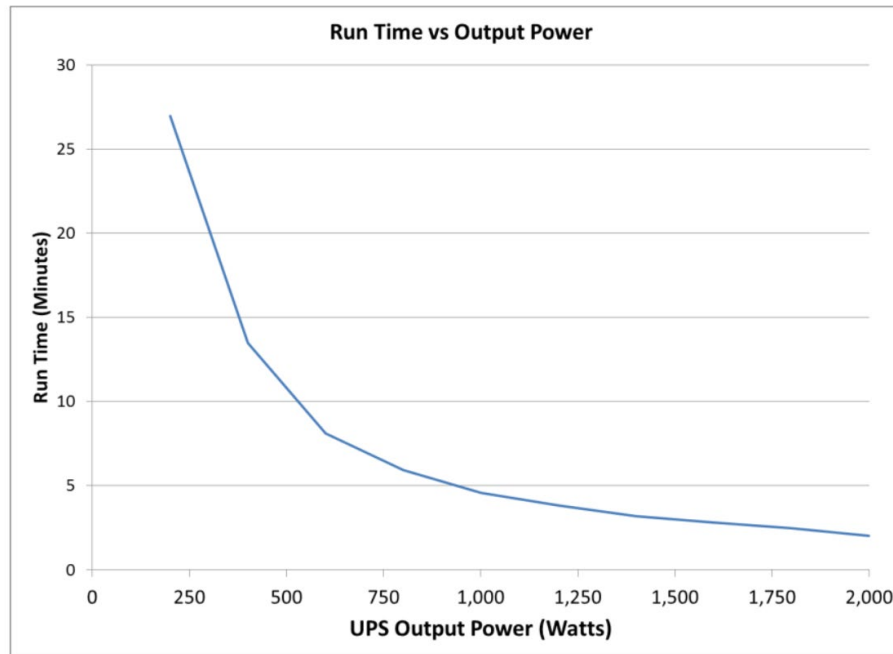

Astrodyne TDI

Now you have power.

www.AstrodyneTDI.com | +1 908-850-5088

© Copyright 2020, Astrodyne, Inc
(and its affiliates, d/b/a Astrodyne TDI)

This document is believed to be correct at the time of publication and Astrodyne, Inc accepts no responsibility for consequences from printing errors or inaccuracies. Specifications are subject to change without notice.