

ADM10 Series 10 Watt Medical DC-DC Converters



Medical



PV



Automation



Datacom



IPC



Industry



Measurement



Telecom



Automobile



Boat



Charger



Railway



2
X
MOPP

5000
VAC
Reinforced
Insulation

4 : 1
Wide
Input
Range

2 : 1
Input
Range

Internal
EN55032
Class
Filter **A**

LOW
Leakage
Current

LOW
Standby
Power

OCP

OVP

SCP

UVP

PART NUMBER STRUCTURE

ADM10 -	48	S	05	W	A	-	P	T
Series Name	Input Voltage (VDC)	Output Quantity	Output Voltage (VDC)	Input Range	Pin Connection Option		Remote On/Off Options	Trim Option
	05:4.5~9 12:9~18 24:18~36 48:36~75	S:Single	3P3:3.3 05:5 12:12 15:15 24:24	□: 2:1	A: A type(Standard) B: B type		□:No pin P:Remote On/Off (Only for B type Pin connection)	□:No Trim T:Trim (Only for B type Pin connection)
		D:Dual	05:±5 12:±12 15:±15					
	24:9~36 48:18~75	S:Single	3P3:3.3 05:5 12:12 15:15 24:24	W: 4:1	A: A type(Standard) B: B type		□:No pin P:Remote On/Off (Only for B type Pin connection)	□:No Trim T:Trim (Only for B type Pin connection)
		D:Dual	05:±5 12:±12 15:±15					

ADM10 Series 10 Watt Medical DC-DC Converters

TECHNICAL SPECIFICATION All specifications are typical at nominal input, full load and 25°C unless otherwise noted

Model Number	Input Range	Output Voltage	Output Current @ Full Load	Input Current @ No Load	Efficiency	Maximum Capacitor Load
	VDC	VDC	mA	mA	%	µF
ADM10-05S3P3A/B	4.5 ~9	3.3	2500	10	80	3000
ADM10-05S05A/B	4.5 ~9	5	2000	10	84	2500
ADM10-05S12A/B	4.5 ~9	12	830	20	86.5	430
ADM10-05S15A/B	4.5 ~9	15	670	20	87	350
ADM10-05S24A/B	4.5 ~9	24	416	20	85.5	125
ADM10-05D05A/B	4.5 ~9	±5	±1000	25	83	± 1440
ADM10-05D12A/B	4.5 ~9	±12	±416	25	85.5	± 250
ADM10-05D15A/B	4.5 ~9	±15	±333	25	86.5	± 180
ADM10-12S3P3A/B	9 ~ 18	3.3	2500	10	83	3000
ADM10-12S05A/B	9 ~ 18	5	2000	10	85.5	2500
ADM10-12S12A/B	9 ~ 18	12	830	10	88	430
ADM10-12S15A/B	9 ~ 18	15	670	10	89	350
ADM10-12S24A/B	9 ~ 18	24	416	10	89	125
ADM10-12D05A/B	9 ~ 18	±5	±1000	10	84	± 1440
ADM10-12D12A/B	9 ~ 18	±12	±416	10	89	± 250
ADM10-12D15A/B	9 ~ 18	±15	±333	10	88	± 180
ADM10-24S3P3A/B	18 ~ 36	3.3	2500	6	83	3000
ADM10-24S05A/B	18 ~ 36	5	2000	6	86.5	2500
ADM10-24S12A/B	18 ~ 36	12	830	6	89	430
ADM10-24S15A/B	18 ~ 36	15	670	6	89	350
ADM10-24S24A/B	18 ~ 36	24	416	6	89	125
ADM10-24D05A/B	18 ~ 36	±5	±1000	6	85	± 1440
ADM10-24D12A/B	18 ~ 36	±12	±416	6	89	± 250
ADM10-24D15A/B	18 ~ 36	±15	±333	6	88	± 180
ADM10-48S3P3A/B	36 ~ 75	3.3	2500	4	82.5	3000
ADM10-48S05A/B	36 ~ 75	5	2000	4	86.5	2500
ADM10-48S12A/B	36 ~ 75	12	830	4	89	430
ADM10-48S15A/B	36 ~ 75	15	670	4	89	350
ADM10-48S24A/B	36 ~ 75	24	416	4	88.5	125
ADM10-48D05A/B	36 ~ 75	±5	±1000	4	85	± 1440
ADM10-48D12A/B	36 ~ 75	±12	±416	4	88	± 250
ADM10-48D15A/B	36 ~ 75	±15	±333	4	88	± 180
ADM10-24S3P3WA/B	9 ~ 36	3.3	2500	6	83	3000
ADM10-24S05WA/B	9 ~ 36	5	2000	6	86.5	2500
ADM10-24S12WA/B	9 ~ 36	12	830	6	89	430
ADM10-24S15WA/B	9 ~ 36	15	670	6	89	350
ADM10-24S24WA/B	9 ~ 36	24	416	6	89	125
ADM10-24D05WA/B	9 ~ 36	±5	±1000	6	85	± 1440
ADM10-24D12WA/B	9 ~ 36	±12	±416	6	89	± 250
ADM10-24D15WA/B	9 ~ 36	±15	±333	6	88	± 180
ADM10-48S3P3WA/B	18 ~ 75	3.3	2500	4	82.5	3000
ADM10-48S05WA/B	18 ~ 75	5	2000	4	86.5	2500
ADM10-48S12WA/B	18 ~ 75	12	830	4	89	430
ADM10-48S15WA/B	18 ~ 75	15	670	4	89	350
ADM10-48S24WA/B	18 ~ 75	24	416	4	88.5	125
ADM10-48D05WA/B	18 ~ 75	±5	±1000	4	85	± 1440
ADM10-48D12WA/B	18 ~ 75	±12	±416	4	88	± 250
ADM10-48D15WA/B	18 ~ 75	±15	±333	4	88	± 180

ADM10 Series 10 Watt Medical DC-DC Converters

INPUT SPECIFICATIONS

Parameter	Conditions		Min.	Typ.	Max.	Unit
Operating input voltage range	2:1	5Vin(nom)	4.5	5	9	VDC
		12Vin(nom)	9	12	18	
	(W) 4:1	24Vin(nom)	18	24	36	VDC
		48Vin(nom)	36	48	75	
Start up voltage	2:1	5Vin(nom)			4.5	VDC
		12Vin(nom)			9	
	(W) 4:1	24Vin(nom)			18	VDC
		48Vin(nom)			36	
Shutdown voltage	2:1	5Vin(nom)	3	4	4.4	VDC
		12Vin(nom)	7	8	8.8	
	(W) 4:1	24Vin(nom)	15	16	17.5	VDC
		48Vin(nom)	31.5	33	34.5	
Start up time	Constant resistive load	Power up		30		ms
Input surge voltage	3 second, max.	2:1	5Vin(nom)		16	VDC
			12Vin(nom)		25	
	3 second, max.	(W) 4:1	24Vin(nom)		50	VDC
			48Vin(nom)		100	
Input filter				Pi type		
Remote ON/OFF	Referred to -Vin pin	DC-DC ON		OPEN or 0 ~ 1.2VDC		
(Only for B-type Pin connection option)		DC-DC OFF		2.2 ~ 12VDC		
		Input current of Ctrl pin	-0.5		1	mA
		Remote off input current		2.5		mA

OUTPUT SPECIFICATIONS

Parameter	Conditions		Min.	Typ.	Max.	Unit
Voltage accuracy			-1.0		+1.0	%
Line regulation	Low Line to High Line at Full Load	Single	-0.2		+0.2	%
		Dual	-0.5		+0.5	
Load regulation	No Load to Full Load	Single	-0.2		+0.2	%
		Dual	-1.0		+1.0	
Cross regulation	Asymmetrical load 25%/100% FL	Dual	-5.0		+5.0	%
Voltage adjustability	Single output	3.3Vout, 5Vout, 12Vout	-10		+10	%
		15Vout, 24Vout	-10		+20	
	Dual output	±5Vout, ±12Vout, ±15Vout	-10		+10	
Ripple and noise	Measured by 20MHz bandwidth With a 10µF/25V X7R MLCC	3.3Vout, 5Vout		30		mVp-p
		12Vout, 15Vout		40		
		24Vout		50		
Temperature coefficient			-0.02		+0.02	%/°C
Transient response recovery time	25% load step change			250		µs
Over voltage protection	Single	3.3Vout	3.7		5	VDC
		5Vout	5.6		7.0	
		12Vout	13.5		16	
		15Vout	18.3		22.0	
		24Vout	29.1		34.5	
Dual	5Vout	5.6		7.0	VDC	
	12Vout	13.5		18.2		
	15Vout	17.0		22.0		
Over load protection	% of Iout rated; Hiccup mode			150		%
Short circuit protection				Continuous, automatic recovery		

ADM10 Series 10 Watt Medical DC-DC Converters

GENERAL SPECIFICATIONS

Parameter	Conditions	Min.	Typ.	Max.	Unit
Isolation voltage	1 minute Reinforced insulation for 250VAC working voltage	5000			VAC
Isolation capacitance			12	17	pF
Leakage current	240VAC, 60Hz			2	μA
Switching frequency		270	300	330	kHz
Clearance/Creepage		8			mm
Safety approvals	IEC/ EN/ ANSI/ AAMI ES60601-1 IEC/ UL/ EN60950-1				UL:E360199 CB: UL(Demko)
Case material					Non-conductive black plastic
Base material					Non-conductive black plastic
Potting material					Silicone (UL94 V-0)
Weight					14g (0.48oz)
MTBF	MIL-HDBK-217F, Full load				3.849 x 10 ⁶ hrs

ENVIRONMENTAL SPECIFICATIONS

Parameter	Conditions	Min.	Typ.	Max.	Unit
Operating ambient temperature	Without derating With derating	-40 +77		+77 +105	°C
Maximum case temperature				+105	°C
Storage temperature range		-55		+125	°C
Thermal impedance			18		°C/W
Thermal shock					MIL-STD-810F
Vibration					MIL-STD-810F
Relative humidity					5% to 95% RH

EMC SPECIFICATIONS

Parameter	Conditions	Level
EMI	EN55011, EN55032 and FCC Part 18 With no external filter With external filter	Class A Class B
ESD	EN61000-4-2 Air ± 15kV and Contact ± 8kV	Perf. Criteria A
Radiated immunity	EN61000-4-3 10 V/m	Perf. Criteria A
Fast transient	EN61000-4-4 ± 2kV	Perf. Criteria A
	ADM10-05□□□□□□ With an aluminum electrolytic capacitor (Nippon Chemi-con KY series, 1000μF/25V) and a reverse diode (Vishay V10P45) in parallel.	
	ADM10-12□□□□□□ ADM10-24□□□□□□ With an aluminum electrolytic capacitor (Nippon Chemi-con KY series, 470μF/50V).	
	ADM10-48□□□□□□ With an aluminum electrolytic capacitor (Nippon Chemi-con KY series, 330μF/100V).	
Surge	EN61000-4-5 ± 2kV	Perf. Criteria A
	ADM10-05□□□□□□ With an aluminum electrolytic capacitor (Nippon Chemi-con KY series, 1000μF/25V) and a reverse diode (Vishay V10P45) in parallel.	
	ADM10-12□□□□□□ ADM10-24□□□□□□ With an aluminum electrolytic capacitor (Nippon Chemi-con KY series, 470μF/50V).	
	ADM10-48□□□□□□ With an aluminum electrolytic capacitor (Nippon Chemi-con KY series, 330μF/100V).	
Conducted immunity	EN61000-4-6 10 Vr.m.s	Perf. Criteria A
Power frequency magnetic field	EN61000-4-8 100A/m continuous; 1000A/m 1 second	Perf. Criteria A

CAUTION: This power module is not internally fused. An input line fuse must always be used.

ADM10 Series 10 Watt Medical DC-DC Converters

CHARACTERISTIC CURVE

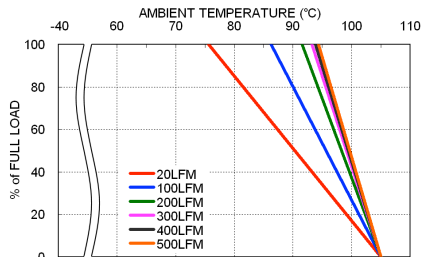

ADM10-48S05WA Derating Curve

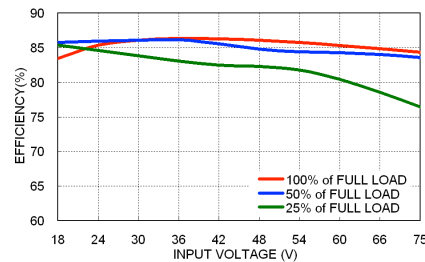

ADM10-48S05WA Efficiency vs. Input Voltage

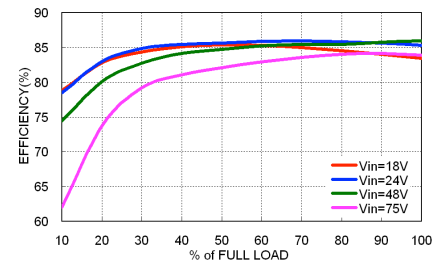

ADM10-48S05WA Efficiency vs. Output Load

FUSE CONSIDERATION

This power module is not internally fused. An input line fuse must always be used.

This encapsulated power module can be used in a wide variety of applications, ranging from simple stand-alone operation to an integrated part of sophisticated power architecture.

To maximum flexibility, internal fusing is not included; however, to achieve maximum safety and system protection, always use an input line fuse.

The input line fuse suggest as below :

Model	Fuse Rating (A)	Fuse Type
ADM10-05S□□□、ADM10-05D□□□	5	Slow-Blow
ADM10-12S□□□、ADM10-12D□□□	2	Slow-Blow
ADM10-24S□□□、ADM10-24D□□□	1	Slow-Blow
ADM10-48S□□□、ADM10-48D□□□	0.5	Slow-Blow

Model	Fuse Rating (A)	Fuse Type
ADM10-24S□□□W、ADM10-24D□□□W	2	Slow-Blow
ADM10-48S□□□W、ADM10-48D□□□W	1	Slow-Blow

The table based on the information provided in this data sheet on inrush energy and maximum DC input current at low Vin.

MECHANICAL DRAWING

A TYPE

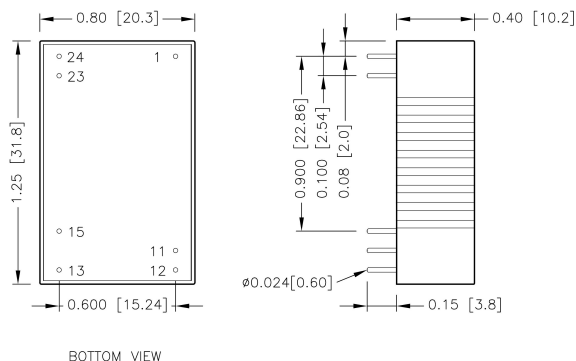

PIN CONNECTION

PIN	SINGLE	DUAL
1	+ Vin	+ Vin
11	No pin	Common
12	-Vout	No pin
13	+Vout	-Vout
15	No pin	+Vout
23	- Vin	- Vin
24	- Vin	- Vin

- All dimensions in inch [mm]
- Tolerance :x.xx±0.02 [x.x±0.5]
x.xxx±0.01 [x.xx±0.25]
- Pin pitch tolerance ±0.01 [0.25]
- Pin dimension tolerance ±0.004[0.10]

ADM10 Series 10 Watt Medical DC-DC Converters

MECHANICAL DRAWING(CONTINUED)

B TYPE

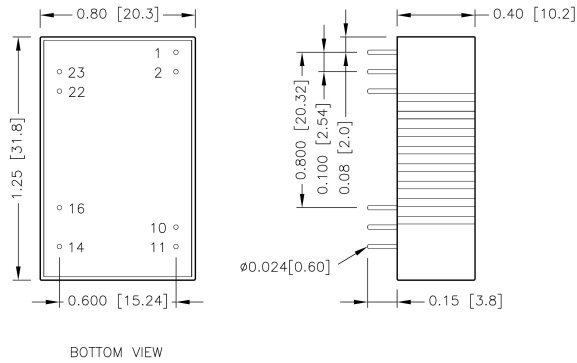

PIN CONNECTION

PIN	SINGLE	DUAL
1	Ctrl (Option) / No pin*	Ctrl (Option) / No pin*
2	- Vin	- Vin
10	Trim (Option) / No pin*	Trim (Option) / No pin*
11	No pin / NC **	-Vout
14	+Vout	+Vout
16	-Vout	Common
22	+Vin	+Vin
23	+Vin	+Vin

* If don't choose Ctrl or Trim option, there is no pin on the corresponding pin number.

** Pin 11 is "No pin" for
ADM10-□□S□□□B-T
ADM10-□□S□□□B-PT
Pin 11 is "NC" for
ADM10-□□S□□□B
ADM10-□□S□□□B-P

1. All dimensions in inch [mm]
2. Tolerance :x.xx±0.02 [x.x±0.5]
x.xxx±0.01 [x.xxx±0.25]
3. Pin pitch tolerance ±0.01 [0.25]
4. Pin dimension tolerance ±0.004[0.10]

RECOMMENDED PAD LAYOUT

A TYPE

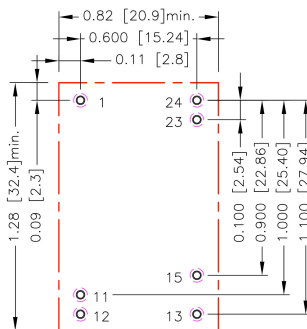

All dimensions in inch[mm]
Pad size(lead free recommended)
Through hole 1.11.12.13.15.23.24: Φ 0.035[0.90]
Top view pad 1.11.12.13.15.23.24: Φ 0.044[1.13]
Bottom view pad 1.11.12.13.15.23.24: Φ 0.071[1.80]

B TYPE

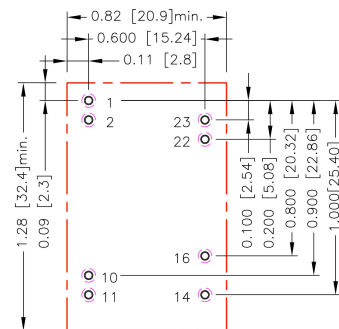

All dimensions in inch[mm]
Pad size(lead free recommended)
Through hole 1.2.10.11.14.16.22.23: Φ 0.035[0.90]
Top view pad 1.2.10.11.14.16.22.23: Φ 0.044[1.13]
Bottom view pad 1.2.10.11.14.16.22.23: Φ 0.071[1.80]

ADM10 Series 10 Watt Medical DC-DC Converters

THERMAL CONSIDERATIONS

The power module operates in a variety of thermal environments. However, sufficient cooling should be provided to help ensure reliable operation of the unit. Heat is removed by conduction, convection, and radiation to the surrounding Environment. Proper cooling can be verified by measuring the point as the figure below. The temperature at this location should not exceed "Maximum case temperature". When Operating, adequate cooling must be provided to maintain the test point temperature at or below "Maximum case temperature". You can limit this Temperature to a lower value for extremely high reliability.

- Thermal test condition with vertical direction by natural convection (20LFM).

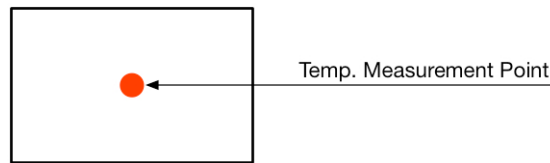

TOP VIEW

OUTPUT VOLTAGE ADJUSTMENT

It allows the user to increase or decrease the output voltage of the module. This is accomplished by connecting an external resistor between the Trim pin and either the +Vout or -Vout pins. With an external resistor between the Trim and -Output pin, the output voltage increases. With an external resistor between the Trim and +Output pin, the output voltage decreases. The external Trim resistor needs to be at least 1/16W of rated power.

Trim Up Equation

$$R_U = \left[\frac{G \times L}{(V_{O,up} - L - K)} - H \right] \Omega$$

Trim Down Equation

$$R_D = \left[\frac{(V_{O,down} - L) \times G}{(V_o - V_{O,down})} - H \right] \Omega$$

Trim constants

Module	G	H	K	L
□□S3P3B-□T、□□S3P3WB-□T	5110	2050	0.8	2.5
□□S05B-□T、□□S05WB-□T	5110	2050	2.5	2.5
□□S12B-□T、□□S12WB-□T	10000	5110	9.5	2.5
□□S15B-□T、□□S15WB-□T	10000	5110	12.5	2.5
□□S24B-□T、□□S24WB-□T	56000	13000	21.5	2.5

Module	G	H	K	L
□□D05B-□T、□□D05WB-□T	3000	3000	7.5	2.5
□□D12B-□T、□□D12WB-□T	56000	13000	21.5	2.5
□□D15B-□T、□□D15WB-□T	30000	13000	27.5	2.5

ADM10 Series 10 Watt Medical DC-DC Converters

OUTPUT VOLTAGE ADJUSTMENT(CONTINUED)

EXTERNAL OUTPUT TRIMMING

Output can be externally trimmed by using the method shown below.

Trim-up

Single Output

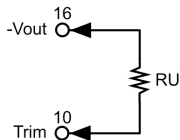

□□S3P3B-□T、□□S3P3WB-□T

ΔV (%)	1	2	3	4	5	6	7	8	9	10
Vout (V)	3.333	3.366	3.399	3.432	3.465	3.498	3.531	3.564	3.597	3.630
RU (k Ω)	385.071	191.511	126.990	94.730	75.374	62.470	53.253	46.340	40.963	36.662

□□S05B-□T、□□S05WB-□T

ΔV (%)	1	2	3	4	5	6	7	8	9	10
Vout (V)	5.050	5.100	5.150	5.200	5.250	5.300	5.350	5.400	5.450	5.500
RU (k Ω)	253.450	125.700	83.117	61.825	49.050	40.533	34.450	29.888	26.339	23.500

Dual Output

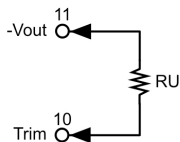

□□S12B-□T、□□S12WB-□T

ΔV (%)	1	2	3	4	5	6	7	8	9	10
Vout (V)	12.120	12.240	12.360	12.480	12.600	12.720	12.840	12.960	13.080	13.200
RU (k Ω)	203.223	99.057	64.334	46.973	36.557	29.612	24.652	20.932	18.038	15.723

□□S15B-□T、□□S15WB-□T

ΔV (%)	1	2	3	4	5	6	7	8	9	10
Vout (V)	15.150	15.300	15.450	15.600	15.750	15.900	16.050	16.200	16.350	16.500
RU (k Ω)	161.557	78.223	50.446	36.557	28.223	22.668	18.700	15.723	13.409	11.557

ΔV (%)	11	12	13	14	15	16	17	18	19	20
Vout (V)	16.650	16.800	16.950	17.100	17.250	17.400	17.550	17.700	17.850	18.000
RU (k Ω)	10.042	8.779	7.711	6.795	6.001	5.307	4.694	4.149	3.662	3.223

□□S24B-□T、□□S24WB-□T

ΔV (%)	1	2	3	4	5	6	7	8	9	10
Vout (V)	24.240	24.480	24.720	24.960	25.200	25.440	25.680	25.920	26.160	26.400
RU (k Ω)	570.333	278.667	181.444	132.833	103.667	84.222	70.333	59.917	51.815	45.333

ΔV (%)	11	12	13	14	15	16	17	18	19	20
Vout (V)	26.640	26.880	27.120	27.360	27.600	27.840	28.080	28.320	28.560	28.800
RU (k Ω)	40.030	35.611	31.872	28.667	25.889	23.458	21.314	19.407	17.702	16.167

□□D05B-□T、□□D05WB-□T

ΔV (%)	1	2	3	4	5	6	7	8	9	10
Vout (V)	± 5.050	± 5.100	± 5.150	± 5.200	± 5.250	± 5.300	± 5.350	± 5.400	± 5.450	± 5.500
RU (k Ω)	72.000	34.500	22.000	15.750	12.000	9.500	7.714	6.375	5.333	4.500

□□D12B-□T、□□D12WB-□T

ΔV (%)	1	2	3	4	5	6	7	8	9	10
Vout (V)	± 12.120	± 12.240	± 12.360	± 12.480	± 12.600	± 12.720	± 12.840	± 12.960	± 13.080	± 13.200
RU (k Ω)	570.333	278.667	181.444	132.833	103.667	84.222	70.333	59.917	51.815	45.333

□□D15B-□T、□□D15WB-□T

ΔV (%)	1	2	3	4	5	6	7	8	9	10
Vout (V)	± 15.150	± 15.300	± 15.450	± 15.600	± 15.750	± 15.900	± 16.050	± 16.200	± 16.350	± 16.500
RU (k Ω)	237.000	112.000	70.333	49.500	37.000	28.667	22.714	18.250	14.778	12.000

ADM10 Series 10 Watt Medical DC-DC Converters

OUTPUT VOLTAGE ADJUSTMENT(CONTINUED)

Trim-down

Single & Dual Output

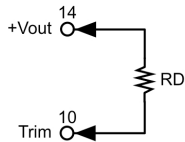

□□S3P3B-□T、□□S3P3WB-□T

ΔV (%)	1	2	3	4	5	6	7	8	9	10
Vout (V)	3.267	3.234	3.201	3.168	3.135	3.102	3.069	3.036	3.003	2.970
RD (k Ω)	116.719	54.779	34.133	23.810	17.616	13.486	10.537	8.325	6.604	5.228

□□S05B-□T、□□S05WB-□T

ΔV (%)	1	2	3	4	5	6	7	8	9	10
Vout (V)	4.950	4.900	4.850	4.800	4.750	4.700	4.650	4.600	4.550	4.500
RD (k Ω)	248.340	120.590	78.007	56.715	43.940	35.423	29.340	24.778	21.229	18.390

□□S12B-□T、□□S12WB-□T

ΔV (%)	1	2	3	4	5	6	7	8	9	10
Vout (V)	11.880	11.760	11.640	11.520	11.400	11.280	11.160	11.040	10.920	10.800
RD (k Ω)	776.557	380.723	248.779	182.807	143.223	116.834	97.985	83.848	72.853	64.057

□□S15B-□T、□□S15WB-□T

ΔV (%)	1	2	3	4	5	6	7	8	9	10
Vout (V)	14.850	14.700	14.550	14.400	14.250	14.100	13.950	13.800	13.650	13.500
RD (k Ω)	818.223	401.557	262.668	193.223	151.557	123.779	103.938	89.057	77.483	68.223

□□S24B-□T、□□S24WB-□T

ΔV (%)	1	2	3	4	5	6	7	8	9	10
Vout (V)	23.760	23.520	23.280	23.040	22.800	22.560	22.320	22.080	21.840	21.600
RD (k Ω)	4947.667	2439.333	1603.222	1185.167	934.333	767.111	647.667	558.083	488.407	432.667

□□D05B-□T、□□D05WB-□T

ΔV (%)	1	2	3	4	5	6	7	8	9	10
Vout (V)	± 4.950	± 4.900	± 4.850	± 4.800	± 4.750	± 4.700	± 4.650	± 4.600	± 4.550	± 4.500
RD (k Ω)	219.000	106.500	69.000	50.250	39.000	31.500	26.143	22.125	19.000	16.500

□□D12B-□T、□□D12WB-□T

ΔV (%)	1	2	3	4	5	6	7	8	9	10
Vout (V)	± 11.880	± 11.760	± 11.640	± 11.520	± 11.400	± 11.280	± 11.160	± 11.040	± 10.920	± 10.800
RD (k Ω)	4947.667	2439.333	1603.222	1185.167	934.333	767.111	647.667	558.083	488.407	432.667

□□D15B-□T、□□D15WB-□T

ΔV (%)	1	2	3	4	5	6	7	8	9	10
Vout (V)	± 14.850	± 14.700	± 14.550	± 14.400	± 14.250	± 14.100	± 13.950	± 13.800	± 13.650	± 13.500
RD (k Ω)	2707.000	1332.000	873.667	644.500	507.000	415.333	349.857	300.750	262.556	232.000