

600 WATT ULTRA LOW CAPACITANCE TVS ARRAY



DESCRIPTION

The SLVU2.8 is a low voltage, low leakage current and ultra low capacitance TVS device designed for EOS and ESD protection of low voltage circuits commonly found in network and computing applications. This device can be placed at the connector input or at the sensitive IC component and also be used across a single ended data line for the protection of a single line.

The SLVU2.8 device meets the IEC requirements of 61000-4-2 (ESD), 61000-4-4 (EFT) and 61000-4-5 (Surge). This device has a peak pulse power rating of 600 Watts (8/20 μ s waveform) and is available in a SOT-23 package configuration.

FEATURES

- Compatible with IEC 61000-4-2 (ESD): Air 15kV, Contact 8kV
- Compatible with IEC 61000-4-4 (EFT): 40A, 5/50ns
- Compatible with IEC 61000-4-5 (Surge): 24A, 8/20 μ s - Level 2(Line-Ground) & Level 3(Line-Line)
- ESD Protection > 25 kilovolts
- 600 Watts Peak Pulse Power per Line($t_p = 8/20\mu$ s)
- Unidirectional Configuration
- Protects 1 Line
- Low Leakage Current < 1.0 μ A
- Ultra Low Capacitance: 2.5pF
- RoHS Compliant
- REACH Compliant

APPLICATIONS

- Ethernet 10/100/1000 Base T
- Routers and Switches
- Audio/Video Inputs
- Portable Electronics

MECHANICAL CHARACTERISTICS

- Molded JEDEC SOT-23 Package
- Approximate Weight: 8 milligrams
- Lead-Free Pure-Tin Plating (Annealed)
- Solder Reflow Temperature:
Pure-Tin - Sn, 100: 260-270°C
- Flammability Rating UL 94V-0
- 8mm Tape and Reel per EIA Standard 481

PIN CONFIGURATION

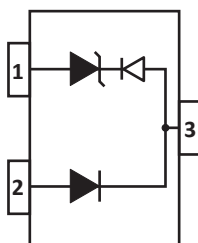

TYPICAL DEVICE CHARACTERISTICS
MAXIMUM RATINGS @ 25°C Unless Otherwise Specified

PARAMETER	SYMBOL	VALUE	UNITS
Peak Pulse Power (tp = 8/20μs) - See Figure 1	P_{PP}	600	Watts
Peak Pulse Current (tp = 8/20μs)	I_{PP}	30	Amps
Repetitive Peak Forward Current @ tp = 5μs, F=50kHz, Pin 2 to 3	I_{FRM}	700	mA
Operating Temperature	T_L	-55 to 150	°C
Storage Temperature	T_{STG}	-55 to 150	°C

ELECTRICAL CHARACTERISTICS PER LINE @ 25°C Unless Otherwise Specified

PART NUMBER (Note 1)	DEVICE MARKING	RATED STAND-OFF VOLTAGE V_{WM} VOLTS	MINIMUM BREAKDOWN VOLTAGE @ 1mA $V_{(BR)}$ VOLTS	MINIMUM SNAP BACK VOLTAGE @ $I_{SB} = 50mA$ V_{SB} VOLTS	MAXIMUM CLAMPING VOLTAGE (Fig. 2) @ $I_P = 2A$ V_C VOLTS	MAXIMUM CLAMPING VOLTAGE (Fig. 2) @ $I_P = 5A$ V_C VOLTS	MAXIMUM CLAMPING VOLTAGE (Fig. 2) @ $I_P = 30A$ V_C VOLTS
SLVU2.8	SLA	2.8	3.0	2.8	3.9	7.0	21.0

NOTES

1. Device measured from pin 3 to 1.

ELECTRICAL CHARACTERISTICS PER LINE @ 25°C Unless Otherwise Specified

MAXIMUM CLAMPING VOLTAGE Pin 2 to 1 (Fig. 2) @ $I_P = 5A$ V_C VOLTS	TYPICAL CLAMPING VOLTAGE Pin 2 to 1 (Fig. 2) @ $I_P = 30A$ V_C VOLTS	MAXIMUM LEAKAGE CURRENT Pin 3 to 1 or Pin 2 to 1 @ V_{WM} I_D μA	TYPICAL CAPACITANCE Pin 3 to 1 & 2 (Tied Together) @ 0V, 1MHz C pF	TYPICAL CAPACITANCE Pin 2 to 1 3 N.C. @ 0V, 1MHz C pF	MAXIMUM PEAK REVERSE VOLTAGE Pin 3 to 2 (Note 1) @ $I_T = 10μA$ V_{RRM} VOLTS	MAXIMUM REVERSE LEAKAGE VOLTAGE Pin 3 to 2 (Note 1) @ $V_{WM} = 2.8V$ I_{DR} μA	MAXIMUM FORWARD VOLTAGE Pin 2 to 3 (Note 1) @ $I_F = 1A$ $T_P = 120μs$ V_F VOLTS
8.5	21.0	1.0	20	2.5	40	0.1	2

NOTES

1. Electrical characteristics for steering diodes.

TYPICAL DEVICE CHARACTERISTICS

FIGURE 1
PEAK PULSE POWER VS PULSE TIME

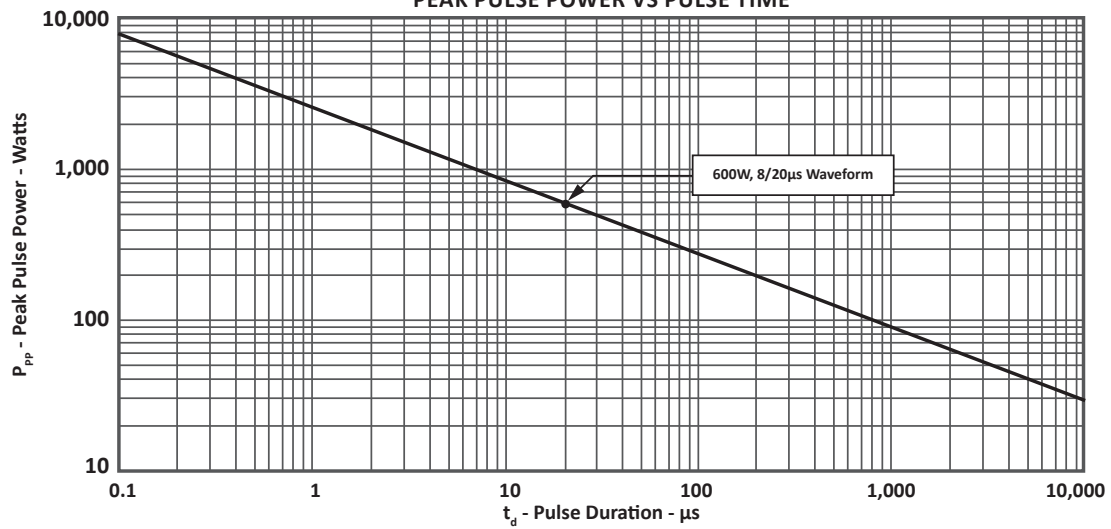
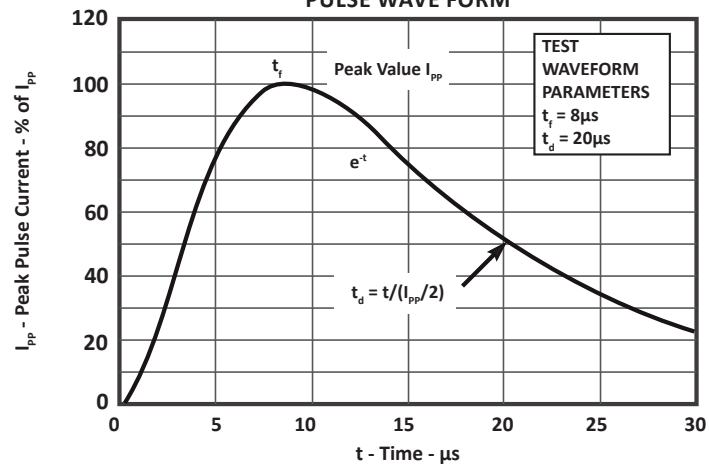
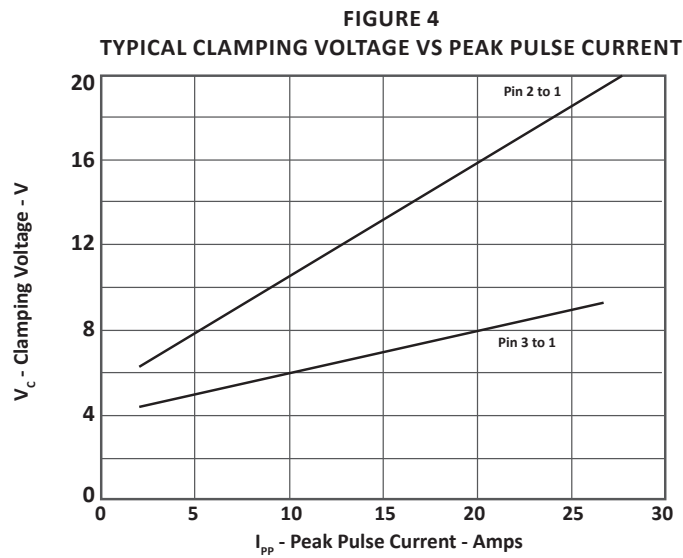
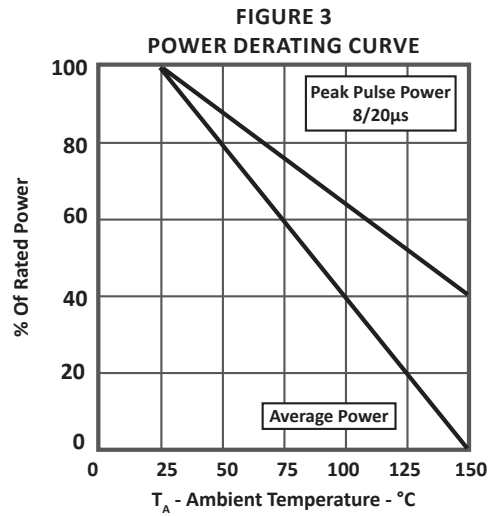

FIGURE 2
PULSE WAVE FORM



TYPICAL DEVICE CHARACTERISTICS



SPICE MODEL

FIGURE 1
SPICE MODEL

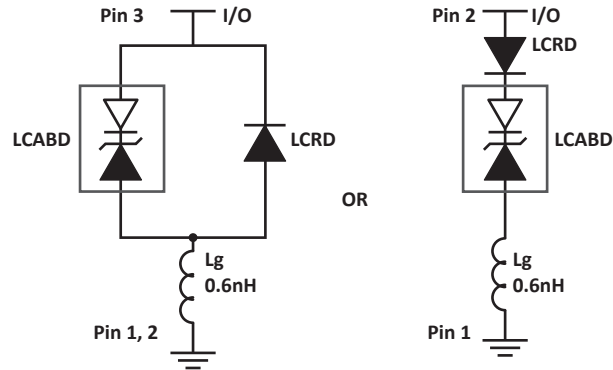

LCABD - Low Capacitance Avalanche Breakdown Diode (TVS)
 LCRD: Low Capacitance Rectifier Diode
 Lg - Lead Inductance

TABLE 1 - SPICE PARAMETERS

PARAMETER	UNIT	ABD(TVS)	LCRD
BV	V	3.3	200
IBV	μA	1	0.01
C_{jo}	pF	20	5
I_s	A	1E-11	1E-13
Vj	V	-	0.6
M	-	0.33	0.33
N	-	1	1
R_s	Ohms	0.28	0.31
TT	s	1E-8	1E-9
EG	eV	1.11	1.11

APPLICATION INFORMATION

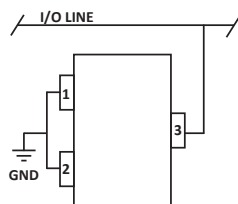

FIGURE 1 - UNIDIRECTIONAL COMMON MODE PROTECTION

Circuit connectivity is as follows:

- Line 1 connected to Pin 3.
- Pins 1 and 2 connected to ground.

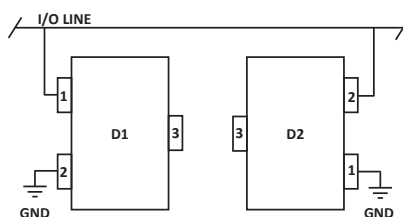

FIGURE 2 - BIDIRECTIONAL COMMON MODE PROTECTION

Two SLUV2.8 devices used in parallel. Circuit connectivity is as follows:

- Line 1 connected to Pin 1 of Device 1 and Pin 2 connected to Device 2.
- Pin 2 of Device 1 and Pin 1 of Device 2 connected to ground.
- Pin 3 of both Devices not connected.

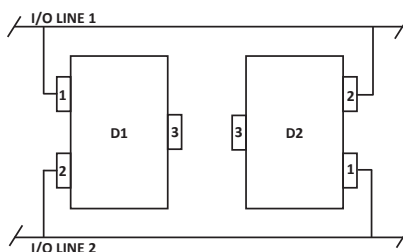

FIGURE 3 - BIDIRECTIONAL DIFFERENTIAL MODE PROTECTION

Two SLUV2.8 devices used in parallel. Circuit connectivity is as follows:

- Line 1 connected to Pin 1 of Device 1 and Pin 2 connected to Device 2.
- Line 2 connected to Pin 2 of Device 1 and Pin 1 of Device 2.
- Pin 3 not connected.

CIRCUIT BOARD RECOMMENDATIONS

Circuit board layout is critical for electromagnetic compatibility protection. The following guidelines are recommended:

- The protection device should be placed near the input terminals or connectors, the device will divert the transient current immediately before it can be coupled into the nearby traces.
- The path length between the TVS device and the protected line should be minimized.
- All conductive loops including power and ground loops should be minimized.
- The transient current return path to ground should be kept as short as possible to reduce parasitic inductance.
- Ground planes should be used whenever possible. For multilayer PCBs, use ground vias.

SOT-23 PACKAGE INFORMATION
OUTLINE DIMENSIONS

DIM	MILLIMETERS		INCHES	
	MIN	MAX	MIN	MAX
A	2.80	3.04	0.110	0.120
B	1.20	1.40	0.047	0.055
C	0.89	1.11	0.035	0.044
D	0.37	0.50	0.015	0.020
G	1.78	2.04	0.070	0.081
H	0.013	0.100	0.001	0.004
J	0.085	0.177	0.003	0.007
K	0.45	0.60	0.018	0.024
L	0.89	1.02	0.035	0.040
S	2.10	2.50	0.083	0.098
V	0.45	0.60	0.018	0.024

NOTES

1. Controlling dimension: inches.
2. Dimensioning and tolerances per ANSI Y14.5M, 1985.
3. Pin 3 is the cathode (Unidirectional Only)
4. Dimensions are exclusive of mold flash and metal burrs.

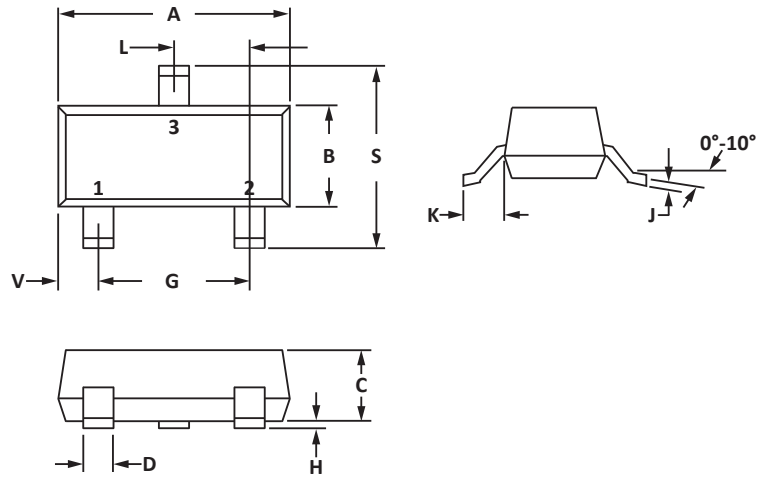
PAD LAYOUT DIMENSIONS

DIM	MILLIMETERS		INCHES	
	MIN	MAX	MIN	MAX
A	0.71	0.97	0.028	0.038
B	1.88	2.13	0.074	0.084
C	0.71	0.97	0.028	0.038
D	0.81	1.07	0.032	0.042

NOTES

1. Controlling dimension: inches.

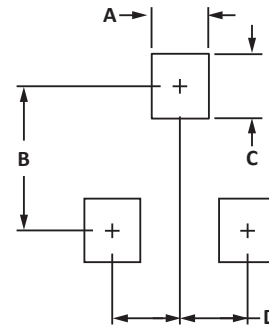

TAPE AND REEL

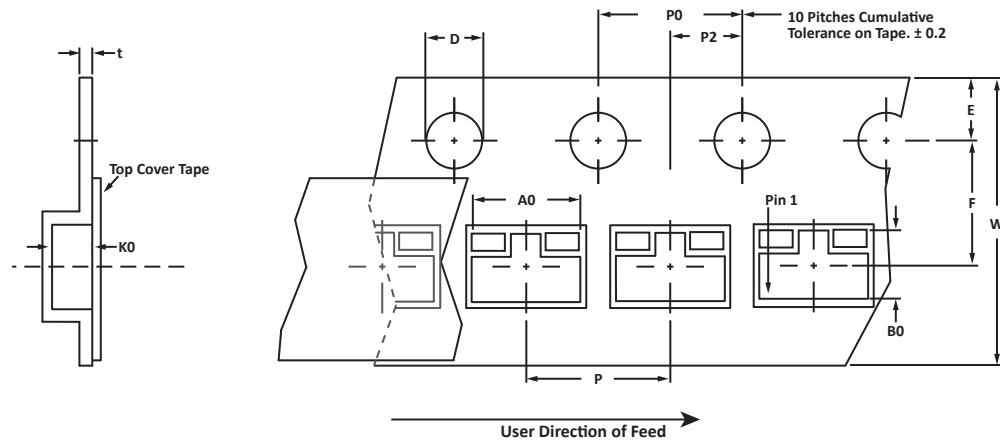

SPECIFICATIONS

REEL DIA.	TAPE WIDTH	A0	B0	K0	D	E	F	W	P0	P2	P	tmax
178mm (7")	8mm	3.15 ± 0.10	2.77 ± 0.10	1.30 ± 0.10	1.55 ± 0.10	1.75 ± 0.10	3.50 ± 0.05	8.00 ± 0.30	4.00 ± 0.10	2.00 ± 0.05	4.00 ± 0.10	0.228

NOTES

- Dimensions are in millimeters.
- Surface mount product is taped and reeled in accordance with EIA-481.
- Suffix - T7 = 7" Reel - 3,000 pieces per 8mm tape.
- Suffix - T13 = 13" Reel - 10,000 pieces per 8mm tape.
- Marking on Part - marking code (see page 2) and date code.

Package outline, pad layout and tape specifications per document number 06012.R2 8/10.

ORDERING INFORMATION

BASE PART NUMBER	LEADFREE SUFFIX	TAPE SUFFIX	QTY/REEL	REEL SIZE	TUBE QTY
SLVU2.8	-LF	-T7	3,000	7"	n/a
SLVU2.8	-LF	-T13	10,000	13"	n/a

This device is only available in a Lead-Free configuration.

COMPANY INFORMATION

COMPANY PROFILE

In business more than 25 years, ProTek Devices™ is a privately held semiconductor company. The company offers a product line of overvoltage protection and overcurrent protection components. These include transient voltage suppressor array (TVS arrays) avalanche breakdown diode, steering diode TVS array and electronics SMD chip fuses. These components deliver circuit protection in electronic systems from numerous overvoltage and overcurrent events. They include lightning; electrostatic discharge (ESD); nuclear electromagnetic pulses (NEMP); inductive switching; and electromagnetic interference (EMI) / radio frequency interference (RFI). ProTek Devices also offers LED wafer die for ESD protection and related high frequency products. ProTek Devices is ISO 9001:2015 certified.

CONTACT US

Corporate Headquarters

2929 South Fair Lane
Tempe, Arizona 85282
USA

By Telephone

General: 602-431-8101
Sales: & Marketing: 602-414-5109
Customer Service: 602-414-5114
Product Technical Support: 602-414-5107

By Fax

General: 602-431-2288

By E-mail:

Asia Sales: asiasales@protekdevices.com
Europe Sales: europesales@protekdevices.com
U.S. Sales: ussales@protekdevices.com
Distributor Sales: distysales@protekdevices.com
Customer Service: service@protekdevices.com
Technical Support: support@protekdevices.com

ProTek Devices (Asia Pacific) Pte. Ltd.

8 Ubi Road 2, #06-19
Zervex
Singapore - 408538
Tel: +65-67488312
Fax: +65-67488313

Web

www.protekdevices.com

COPYRIGHT © ProTek Devices 2001 - This literature is subject to all applicable copyright laws and is not for resale in any manner.

SPECIFICATIONS: ProTek reserves the right to change the electrical and or mechanical characteristics described herein without notice.

DESIGN CHANGES: ProTek reserves the right to discontinue product lines without notice and that the final judgement concerning selection and specifications is the buyer's and that in furnishing engineering and technical assistance. ProTek assumes no responsibility with respect to the selection or specifications of such products. ProTek makes no warranty, representation or guarantee regarding the suitability of its products for any particular purpose, nor does ProTek assume any liability arising out of the application or use of any product or circuit and specifically disclaims any and all liability without limitation special, consequential or incidental damages.

LIFE SUPPORT POLICY: ProTek Devices products are not authorized for use in life support systems without written consent from the factory.