



INSTALLATION MANUAL
TITAN 46 28VDC

AVE-TID46-IM

TABLE OF CONTENTS

PART 0 DOCUMENT ADMINISTRATION 3

0.1 DOCUMENT APPROVAL3

0.2 AMENDMENT RECORD PROCEDURE.....4

0.3 AFFECTED PAGES PROCEDURE.....4

PART 1 INSTALLATION DATA 5

1.1 TITAN™ 46 28VDC5

1.2 OPERATING INSTRUCTIONS5

1.3 INSTALLATION SCHEMATIC / WIRING DIAGRAM5

1.4 CONTROL & POWER INPUTS5

1.5 TECHNICAL SPECIFICATION6

1.6 TECHNICAL DRAWING.....7

1.7 WIRING CHART8

1.8 OPTIC SIMULATION9

1.9 EQUIPMENT LIMITATION 10

1.10 CARE AND CLEANING OF LIGHTS 10

1.11 TESTING THE LIGHTS BEFORE INSTALLATION 10

1.12 CONTINUED AIRWORTHINESS INFORMATION 11

Part 0 Document Administration

0.1 Document Approval

This document has been established in accordance with an alternative procedure to DOA approved under EASA AP429.

This installation manual is applicable for following part numbers:

- **TITAN 46 28VDC - Taxi** - AVE-TID46TW-TD1
- **TITAN 46 28VDC - Landing** - AVE-TID46LW-TD1

Compiled by: _____ 9 September 2020

Petr Jaroš
Engineer, Aveo Engineering Group, s.r.o.

Approved by: _____ 9 September 2020
Georg Hartl
Head of DO, Aveo Engineering Group, s.r.o.

0.2 Amendment Record Procedure

The master copy of this document shall be kept electronically as a read only document under the control of Aveo Engineering Group, s.r.o. as Master Copy.

ALL amendments to this manual will initiate a raise of issue.

The original issue will be identified by "01", and subsequent issues will be numbered sequentially from 02 to 99 in Table 01 - **Issue No.** column.

ALL issues of this document will be approved by Head of DO.

Issue No.	Details	Date of issue	Affected Pages
01	Initial Issue	29 April 2020	ALL
Table 01: Record of Document Amendments			

0.3 Affected Pages Procedure

ALL pages affected by ANY raise of issue of this document will be listed in Table 01 - **Affected Pages** Column.

The reason(s) for **EACH** raise of issue and the description of respective change will be provided in Table 01 - **Details** Column.

Changes from the previous issue are shown as follows:

- a) new text is highlighted with yellow shading: **new**
- b) deleted text is shown with yellow shading and a strike through: ~~**deleted**~~

Part 1 Installation data

1.1 TITAN™ 46 28VDC

TITAN™ 46 28VDC is a high powered PAR46 LED light use in GA and transport category aircraft. It has been designed to be lightweight and with a low power draw to meet the highest requirements of all certified aircraft.

- **TITAN 46 28VDC - Taxi** - AVE-TID46TW-TD1
- **TITAN 46 28VDC - Landing** - AVE-TID46LW-TD1

1.2 Operating Instructions

When installed on the aircraft, using the aircraft's power (28 volts), the light will be at its maximum intensity.

Operating Voltage range is +18...+36VDC.

1.3 Installation Schematic / Wiring Diagram

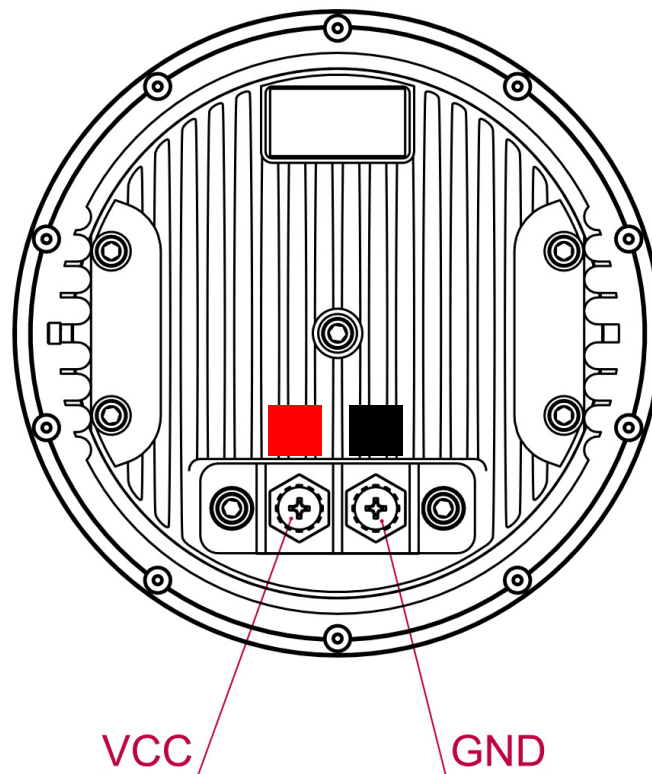

1.4 Control & Power Inputs

BLACK Ground
RED Power

1.5 *Technical Specification*

Light characteristics: Landing Light or Taxi Light / PAR46 replacement
Voltage range: 18-36VDC
Voltage protection: a. Transient voltage: 2 second +80VDC
 b. Under-voltage lockout: +17VDC, not more
 c. Over-voltage lockout: +36.7VDC, not less
LED quantity: 18 pcs
Performance: Input current: 4.46A @ 28VDC
 Input power: 125W
Chromaticity: Cool White
Low temp. slope start: -55°C / -67°F
Ambient temperature: -55°C...+85°C / -67°F...+185°F
Overheat protection: Yes
Wiring: N/A, Terminal Block – 2 contacts
Weight: 950 g / 33.51 oz
Useful life: not less than 30.000 aircraft flight hours.

Viewing Angle:

AVE-TID46LW-TD1
Landing Lens: 5°

AVE-TID46TW-TD1
Taxi Lens: 45° x 10° and 5°

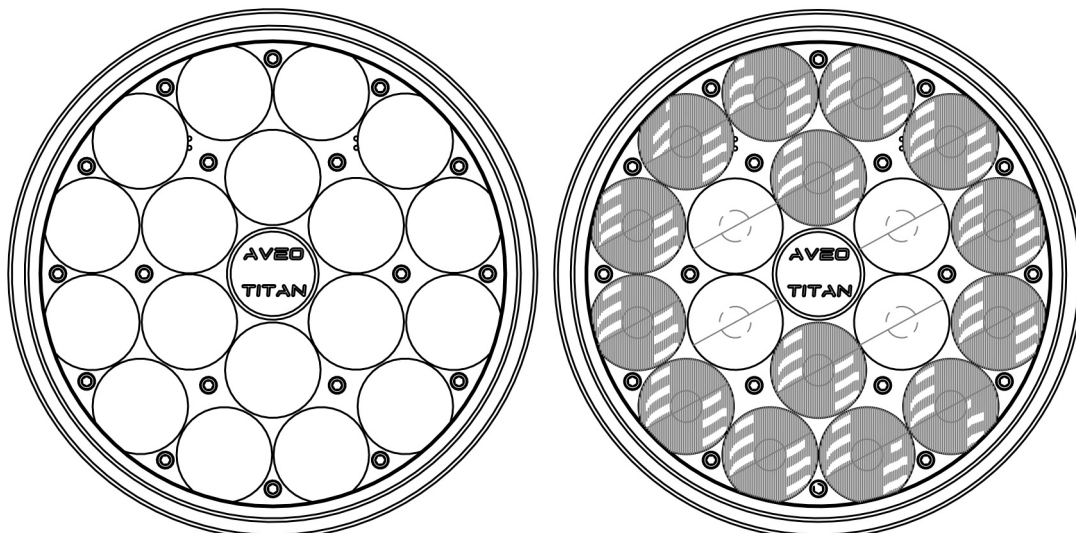

Device RTCA/DO160 qualified:

- chapter 4, Temperature - Altitude, Category F2
- chapter 5, Temperature Variation, Category A
- chapter 6, Humidity, Category C
- chapter 7, Operational Shocks and Crash Safety, Category B
- chapter 8, Vibration, Category U curve G, R curve W
- chapter 9, Explosion proofness, Category H
- chapter 10, Waterproofness, Category R
- chapter 11, Fluids Susceptibility, Category F
- chapter 12, Sand and Dust, Category D
- chapter 13, Fungus resistance, Category F
- chapter 14, Salt spray, Category T
- chapter 15, Magnetic effects, Category Z
- chapter 16, Power Input, Category ZXX
- chapter 17, Voltage Spike, Category A
- chapter 18, Audio Frequency Conducted Susceptibility, Category Z
- chapter 19, Induced Signal Susceptibility, Category ZCX
- chapter 20, Radio Frequency Susceptibility, Category TT
- chapter 21, Emission of Radio Frequency Energy, **Category L**
- chapter 22, Lightning induced transient susceptibility test, Category A2E2X
- chapter 24, Icing, Category A
- chapter 25, Electrostatic Discharge (ESD), Category A

1.6 Technical Drawing

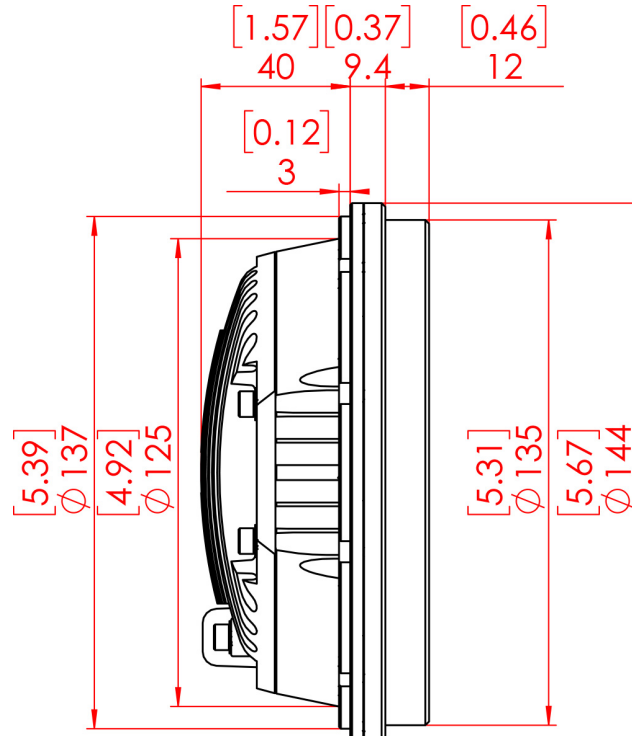

*dimensions in [inches] / mm

1.7 Wiring Chart

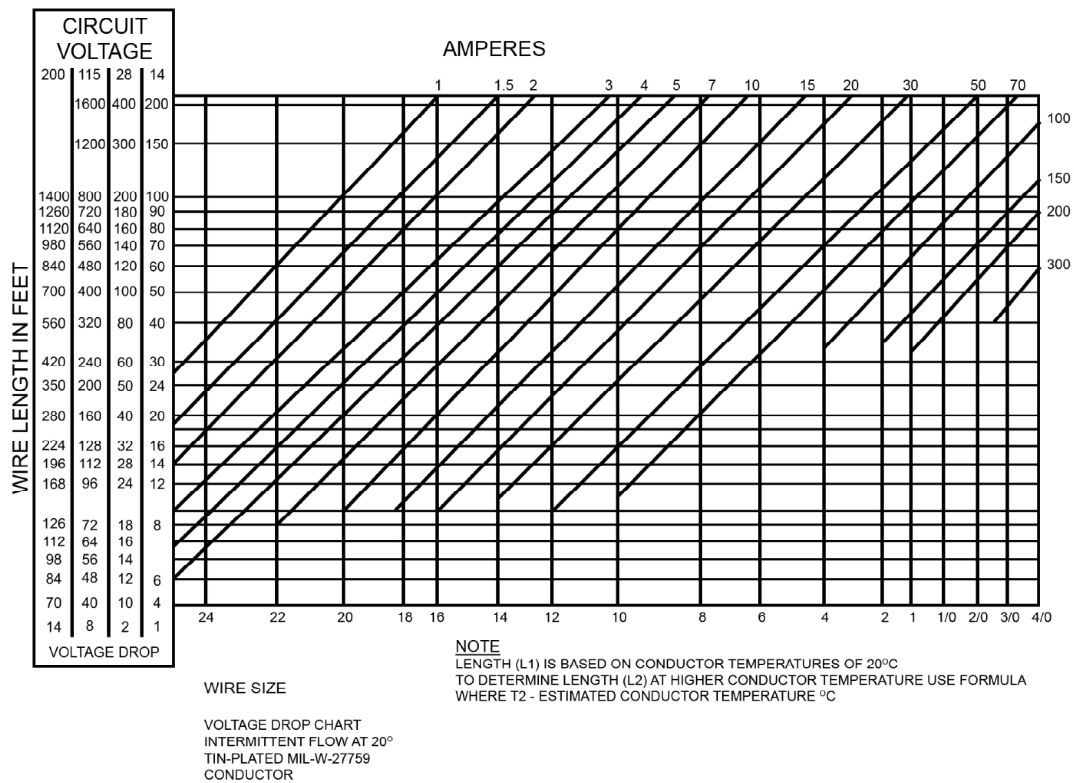

1.8 Optic Simulation

Landing Version

606 000 cd

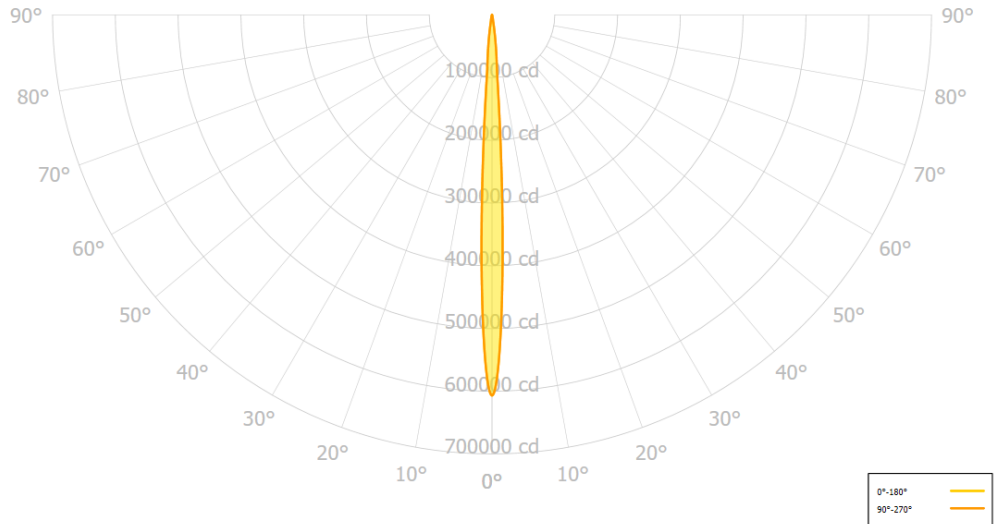

Taxi Version

220 000 cd

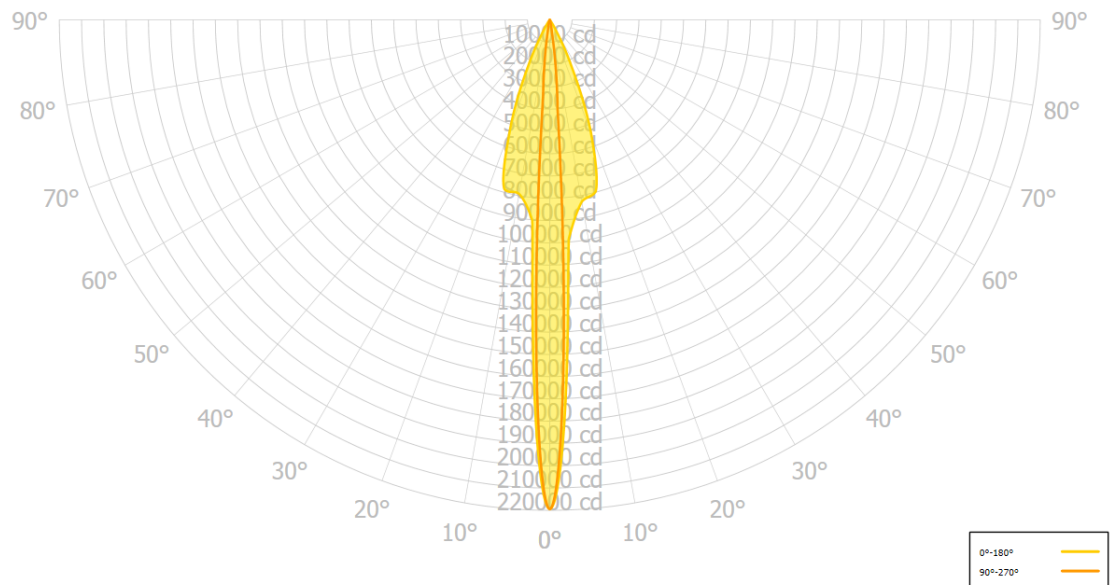

1.9 Equipment Limitation

TITAN 46 28VDC should only be powered by 18-36VDC

1.10 Care and Cleaning of Lights

Aveo Engineering Aviation Lights are factory polished and delivered as ready to install on the aircraft.

If the lights need a deeper cleaning, they should be polished with a quality lamb's wool sheet that is suitable also for deeper polishing. Under no circumstances should any petroleum based product be used to clean the lights.

1.11 Testing the Lights before Installation

All Aveo Aviation lights undergo rigorous testing prior to being released from our engineering manufacturing department. This testing involves a burn-in time as well as other function testing. No light is released for sale without undergoing this extensive operational testing.

When you receive the **TITAN 46 28VDC** light, and wish to test the function of the light prior to installation on your aircraft, please note the following:

1. Please review the written information that is enclosed in the packaging. Warranty information as well as a cautionary note about power supply removal is enclosed with each package.
2. Remove the light from the package. Note that there is terminal block with 2 colors:
 - Black – Ground
 - Red – Power
3. Testing of the function of the light can be done with a regular 28VDC power supply (not a battery charger). Connect the ground wire to black pole and then connect the power wire to the red pole. The TITAN 46 28VDC light should start lighting. When installed on the aircraft, using the aircraft's power (28VDC), the light will be at its maximum intensity.

After testing, the light can be installed on the aircraft.

IMPORTANT NOTES:

Under no circumstances should any power supply other than a 18-36VDC, or a 28 volt battery be used to test the light. Do not use: Battery chargers, battery back-up power devices, or other bench avionics testing methods to test the aviation light. The light is functional between 18-36 volts. Use of a battery charger or other power unit to test the light will void the warranty and may damage the light.

If you have any questions about the installation of the lights, please refer to our web site: www.aveoengineering.com

1.12 Continued Airworthiness Information

Circuit/Wiring Protection

Each Titan series light features a **Negative Temperature Coefficient** (NTC) circuit that limits internal temperatures by attenuating operating current (with a corresponding reduction of brightness) when internal temperatures reach a certain threshold. This proprietary circuitry serves to protect the light itself, and associated aircraft wiring, against a thermal runaway condition.

Periodic Inspection Procedure

The Titan lights should always be checked for proper operation during preflight. This procedural information is already provided in all general aviation aircraft flight manuals.

The lights should be visually inspected for general condition, proper operation, and correct installation during inspection as defined in the aircraft maintenance manual (AMM). Any debris or atmospheric deposits accumulated on the surface of the lights should be removed using a UV Wax such as Farecia Profile UV Wax to ensure ongoing optical clarity.

For inspection turn the lights on and do the following:

1. Put on polarized sunglasses or welder goggles to prevent eye damage when looking into the lights.
2. Examine the individual LEDs. If any LED failed, the light shall be removed and sent to Aveo Engineering for replacement under the Aveo Warranty Program.