

NTC Thermistor : TTC05 Series



Φ5 mm Lead Type for Temperature Sensing/Compensation

■ Features

1. RoHS compliant
2. Halogen-Free (HF) series are available
3. Body size: Φ5mm
4. Radial lead resin coated
5. Operating temperature range: -30°C~+125°C
6. Wide resistance range
7. Cost effective
8. Agency recognition: UL / cUL / TUV / CQC



■ Recommended Applications

1. Home appliances
2. Automotive electronics
3. Computers
4. Switch mode power supplies
5. Adapters

■ Part Number Code

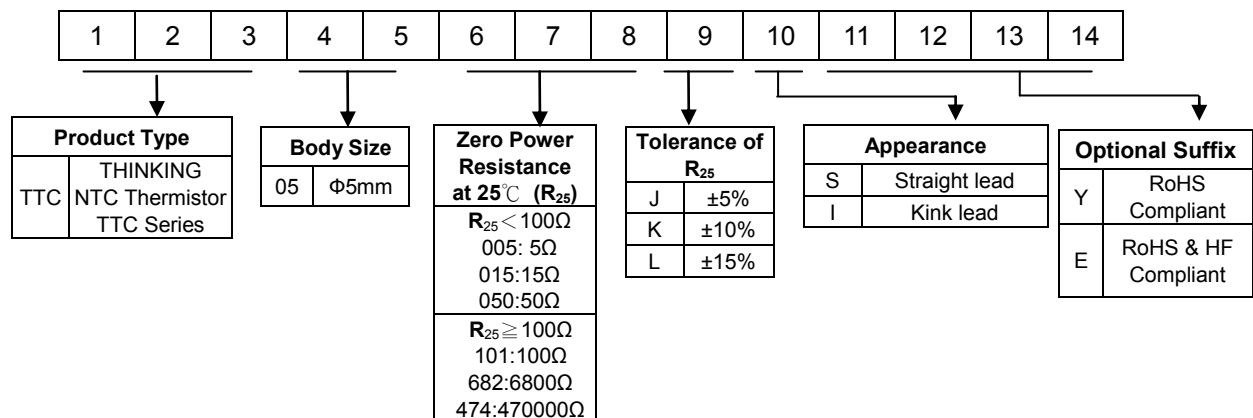

■ Structure and Dimensions

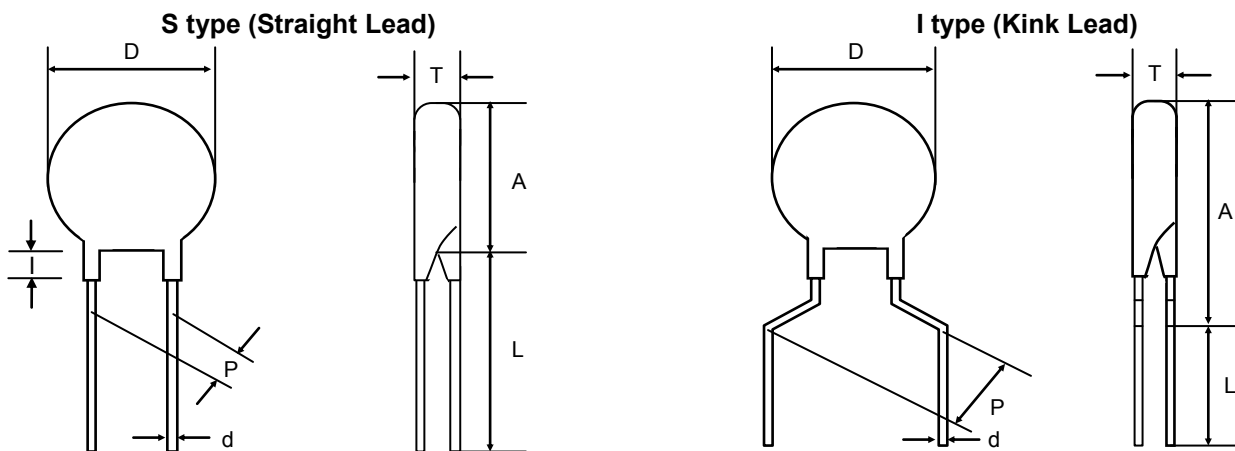

(Unit: mm)

Type	D	P	d	I max.	A max.	L min.	T
S Type	4.0~6.5	3.5± 0.5	0.5±0.02	3	6.5	31	2.5~5.0
I Type	4.0~6.5	5± 0.5	0.5±0.02	—	10	29	2.5~5.0

NTC Thermistor : TTC05 Series



Φ5 mm Lead Type for Temperature Sensing/Compensation

■ Electrical Characteristics

Part No.	Zero Power Resistance at 25°C	Tolerance of R ₂₅	B _{25/50} Value	Max. Power Dissipation at 25°C	Dissipation Factor	Thermal Time Constant	Operating Temperature Range	Safety Approvals							
	R ₂₅ (Ω)	(±%)	(K)	P _{max} (mW)	δ(mW/°C)	τ (Sec.)	T _L ~T _U (°C)	UL/cUL	TUV	CQC					
TTC05005□	5	10, 15	2400	450	Approx. 4.5	Approx. 20	-30~+125		√	√					
TTC05010□	10							2800					√	√	
TTC05015□	15							2800					√	√	√
TTC05020□	20							2800					√	√	√
TTC05025□	25							2900					√	√	√
TTC05045□	45							3100					√	√	√
TTC05050□	50							3100					√	√	√
TTC05060□	60							3100					√	√	√
TTC05085□	85							3200					√	√	√
TTC05090□	90							3200					√	√	√
TTC05101□	100							3200					√	√	√
TTC05121□	120							3300					√	√	√
TTC05151□	150							3300					√	√	√
TTC05201□	200							3500					√	√	√
TTC05221□	220							3500					√	√	√
TTC05251□	250							3500					√	√	√
TTC05301□	300							3800					√	√	√
TTC05471□	470							3500					√	√	√
TTC05501□	500							3700					√	√	√
TTC05681□	680							3800					√	√	√
TTC05701□	700							3800					√	√	√
TTC05102□	1000							3800					√	√	√
TTC05152□	1500							3950					√	√	√
TTC05202□	2000							4000					√	√	√
TTC05222□	2200							4000					√	√	√
TTC05252□	2500							4000					√	√	√
TTC05302□	3000							4000					√	√	√
TTC05332□	3300							4000					√	√	√
TTC05402□	4000		4000					√	√	√					
TTC05472□	4700		4050					√	√	√					
TTC05502□	5000		3950					√	√	√					
TTC05602□	6000		4050					√	√	√					
TTC05682□	6800		4050					√	√	√					
TTC05802□	8000		4050					√	√	√					
TTC05103□	10000	5, 10, 15	4050					√	√	√					
TTC05123□	12000			4050					√	√	√				
TTC05153□	15000			4150					√	√	√				
TTC05203□	20000			4250					√	√	√				
TTC05303□	30000			4250					√	√	√				
TTC05473□	47000			4300					√	√	√				
TTC05503□	50000			4300					√	√	√				
TTC05104□	100000			4400					√	√	√				
TTC05154□	150000			4500					√	√	√				
TTC05204□	200000			4600					√	√	√				
TTC05224□	220000			4600					√	√	√				
TTC05474□	470000			4750					√	√	√				

Note 1: □ = Tolerance of R₂₅

Note 2: UL/cUL File No: E138827

CSA File No: 97495

TUV File No: R 50050155

CQC File No: CQC05001011991 ; CQC05001011994

Note 3: Special specifications are available upon request.

NTC Thermistor : TTC05 Series



Φ5 mm Lead Type for Temperature Sensing/Compensation

Max. Power Dissipation Derating Curve

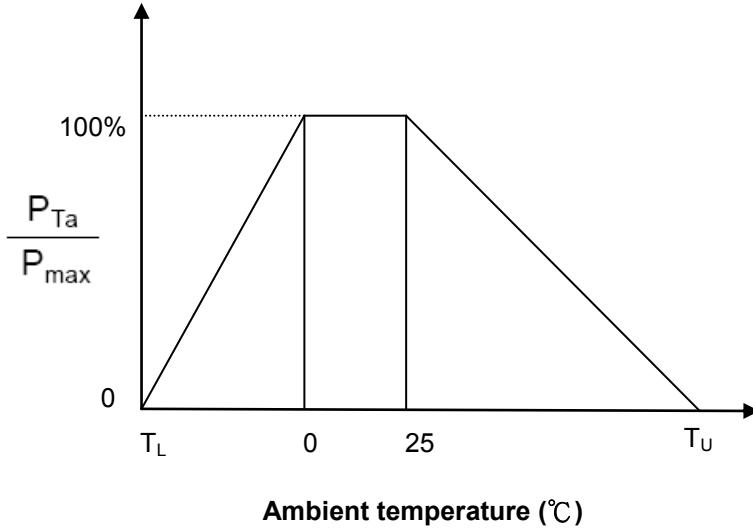

T_U : Maximum operating temperature (°C)

T_L : Minimum operating temperature (°C)

For example:

Ambient temperature (T_a) = 55°C

Maximum operating temperature (T_U) = 125°C

$$P_{Ta} = (T_U - T_a) / (T_U - 25) \times P_{max} = 70\% P_{max}$$

R-T Characteristic Curves (representative)

TTC05005~TTC05681

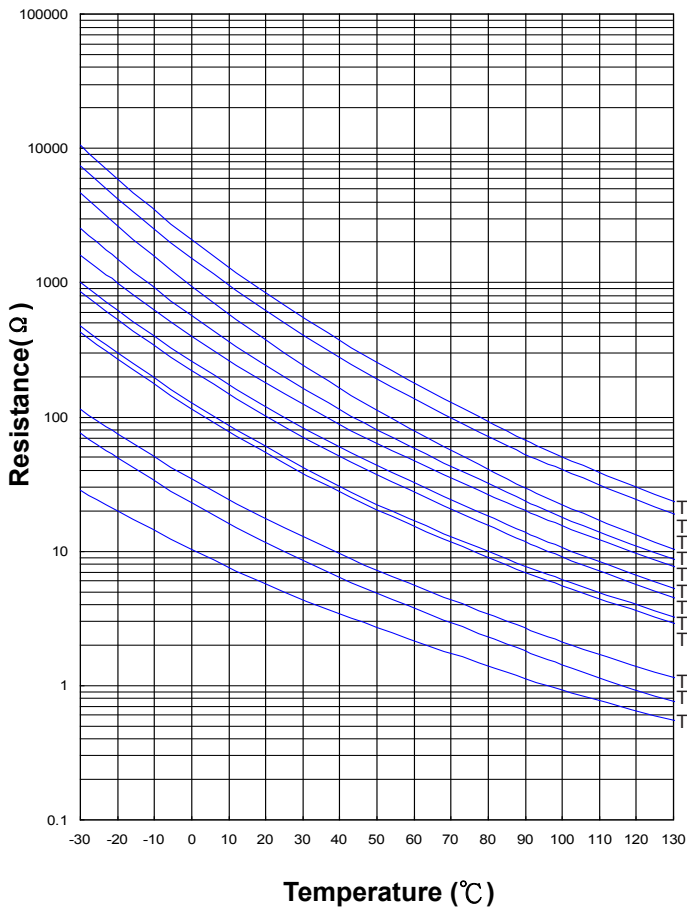

TTC05102~TTC05104

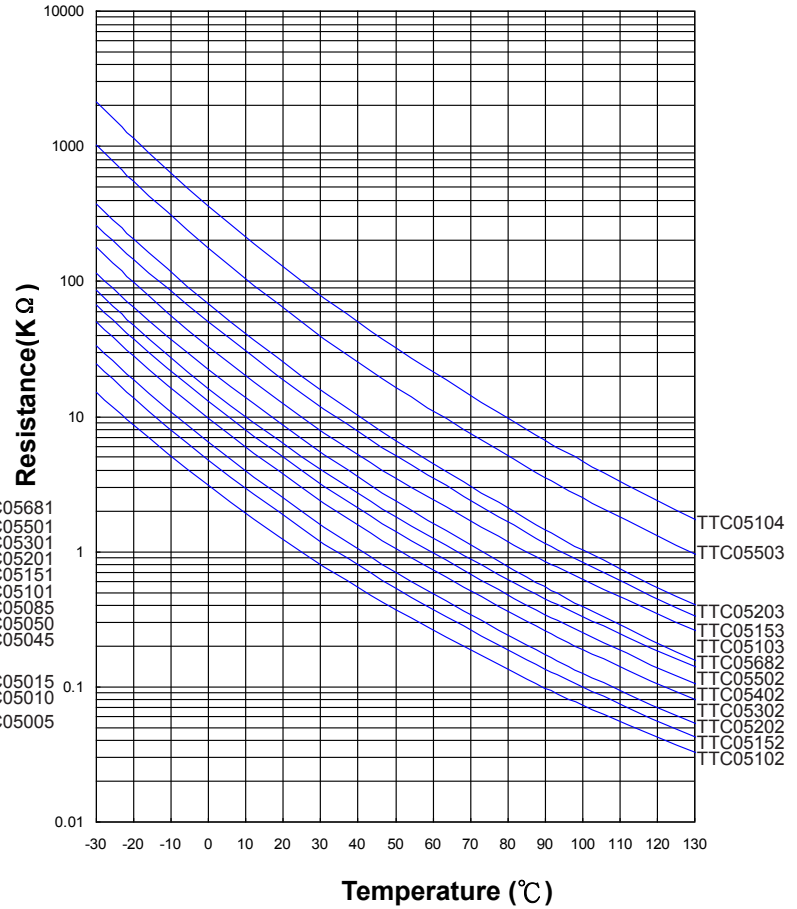

NTC Thermistor : TTC05 Series



Φ5 mm Lead Type for Temperature Sensing/Compensation

■ V-I Characteristic Curves (representative)

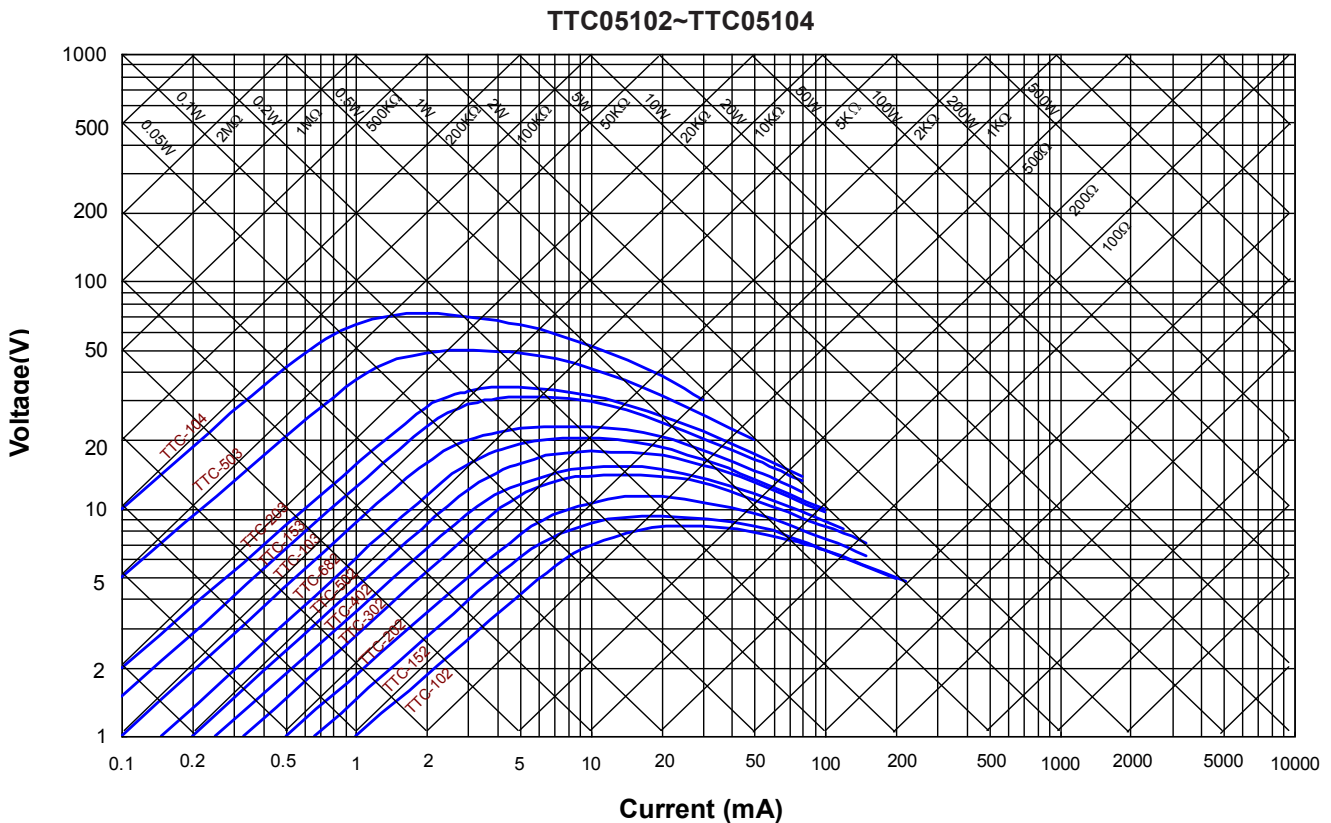
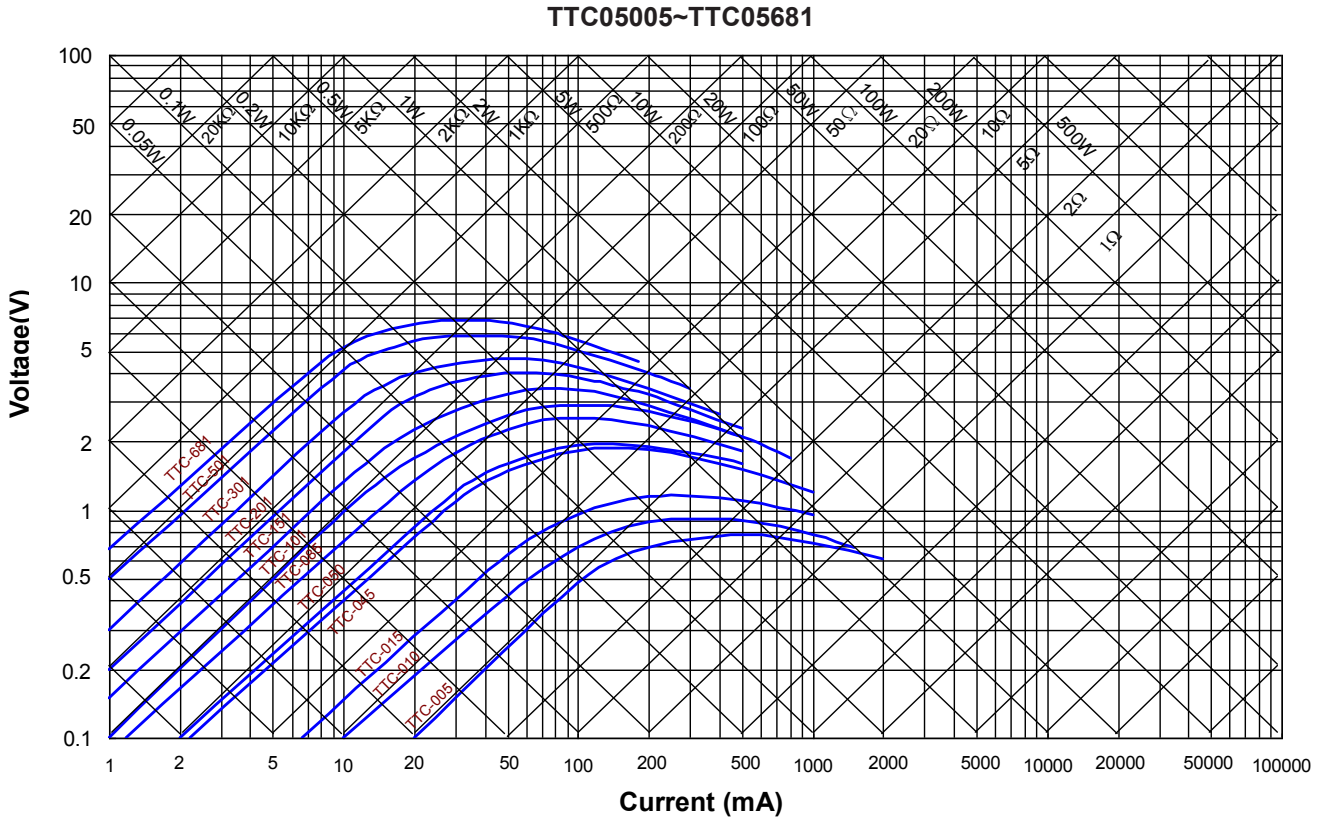

NTC Thermistor : TTC05 Series



Φ5 mm Lead Type for Temperature Sensing/Compensation

■ Soldering Recommendation

● Wave Soldering Profile

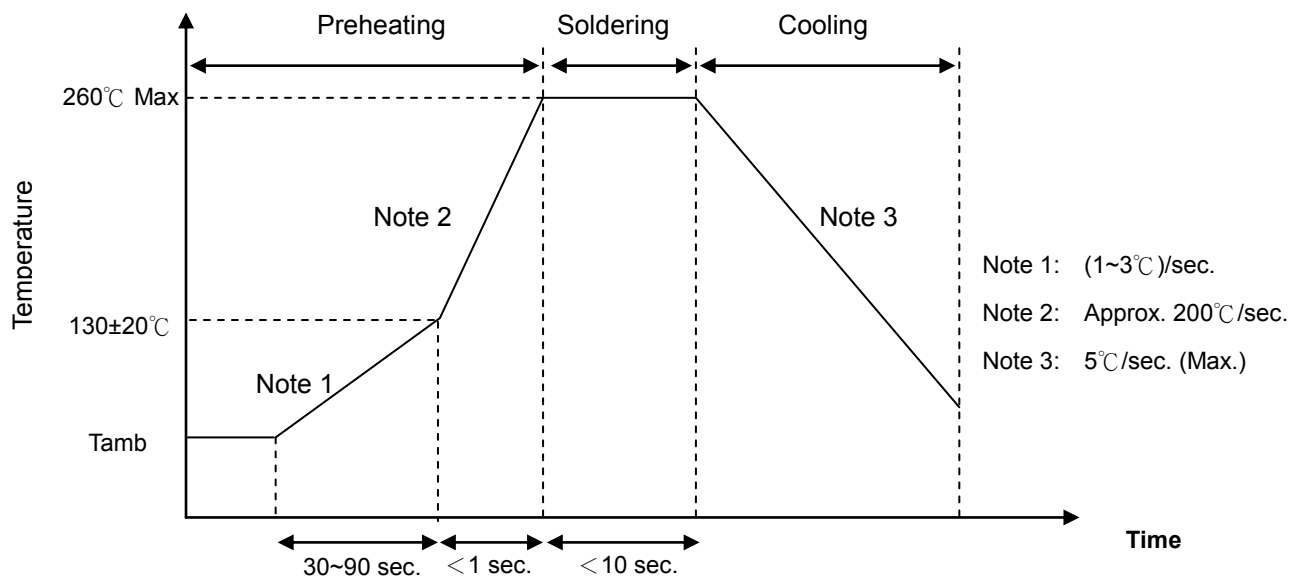

Caution: It had better to keep the minimum distance as 6mm between the bottom of the thermistor body and PCB surface to prevent component damage.

● Recommended Reworking Conditions with Soldering Iron

Item	Conditions
Temperature of Soldering Iron-tip	360°C (max.)
Soldering Time	3 sec. (max.)
Distance from Thermistor	2 mm (min.)

NTC Thermistor : TTC05 Series



Φ5 mm Lead Type for Temperature Sensing/Compensation

■ Reliability

Item	Standard	Test conditions / Methods	Specifications															
Tensile Strength of Terminals	IEC 60068-2-21	Gradually apply the specified force and keep the unit fixed for 10±1 sec. Terminal diameter (mm) $0.3 < d \leq 0.5$ Force (Kg) 0.5	No visible damage															
Bending Strength of Terminals	IEC 60068-2-21	Hold specimen and apply the force specified below to each lead. Bend the specimen to 90°, and then return to the original position. Repeat the procedure in the opposite direction. Terminal diameter (mm) $0.3 < d \leq 0.5$ Force (Kg) 0.25	No visible damage															
Solderability	IEC 60068-2-20	245 ± 3 °C , 3 ± 0.3 sec.	At least 95% of terminal electrode is covered by new solder															
Resistance to Soldering Heat	IEC 60068-2-20	260 ± 3 °C , 10 ± 1 sec.	No visible damage ΔR ₂₅ /R ₂₅ ≤ 3 %															
High Temperature Storage	IEC 600068-2-2	125 ± 5 °C , 1000 ± 24 hrs	No visible damage ΔR ₂₅ /R ₂₅ ≤ 5 %															
Damp Heat, Steady State	IEC 60068-2-78	40 ± 2 °C , 90~95% RH, 1000 ± 24 hrs	No visible damage ΔR ₂₅ /R ₂₅ ≤ 3 %															
Rapid Change of Temperature	IEC 60068-2-14	The conditions shown below shall be repeated 5 cycles. <table border="1" style="margin-left: auto; margin-right: auto;"> <thead> <tr> <th>Step</th> <th>Temperature (°C)</th> <th>Period (minutes)</th> </tr> </thead> <tbody> <tr> <td>1</td> <td>-30 ± 5</td> <td>30 ± 3</td> </tr> <tr> <td>2</td> <td>Room temperature</td> <td>5 ± 3</td> </tr> <tr> <td>3</td> <td>125 ± 5</td> <td>30 ± 3</td> </tr> <tr> <td>4</td> <td>Room temperature</td> <td>5 ± 3</td> </tr> </tbody> </table>	Step	Temperature (°C)	Period (minutes)	1	-30 ± 5	30 ± 3	2	Room temperature	5 ± 3	3	125 ± 5	30 ± 3	4	Room temperature	5 ± 3	No visible damage ΔR ₂₅ /R ₂₅ ≤ 3 %
Step	Temperature (°C)	Period (minutes)																
1	-30 ± 5	30 ± 3																
2	Room temperature	5 ± 3																
3	125 ± 5	30 ± 3																
4	Room temperature	5 ± 3																
Max. Power Dissipation	IEC 60539-1 4.26.3	25 ± 5 °C , Pmax. , 1000 ± 24 hrs	No visible damage ΔR ₂₅ /R ₂₅ ≤ 5 %															
Insulation Test	MIL-STD-202F -Method 302	1000 V _{DC} , 1 min	≥ 500 MΩ															

NTC Thermistor : TTC05 Series



Φ5 mm Lead Type for Temperature Sensing/Compensation

■ Packaging

● Taping Specification :

S Type (Straight Lead)

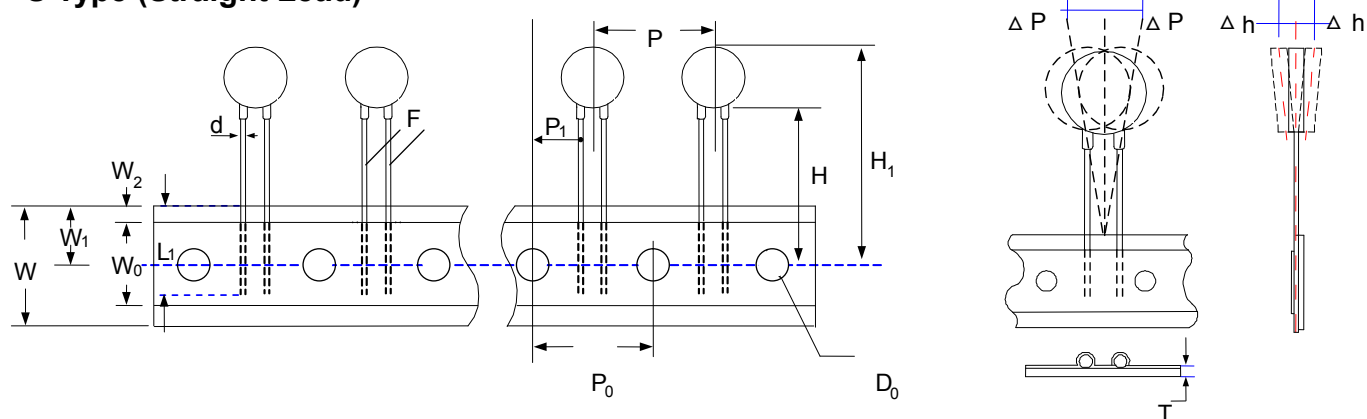

Taping Dimension	P ₀	F	P	P ₁	H	H ₁	d	W ₀	W ₁	W ₂	W	Δ P	Δ h	L ₁	D ₀	T
	±0.3	±0.5	±1	±0.7	+2/-0	Max.	±0.02	±1	+0.75 /-0.5	Max.	+1/ -0.5	Max.	Max.	Min.	±0.2	±0.2
P ₀ :12.7	12.7	3.5	12.7	4.60	18	28	0.5	12	9	3	18	1	2	9	4	0.6
P ₀ :15.0	15.0	3.5	15.0	5.75	18	28	0.5	12	9	3	18	1	2	9	4	0.6

I Type (Kink Lead)

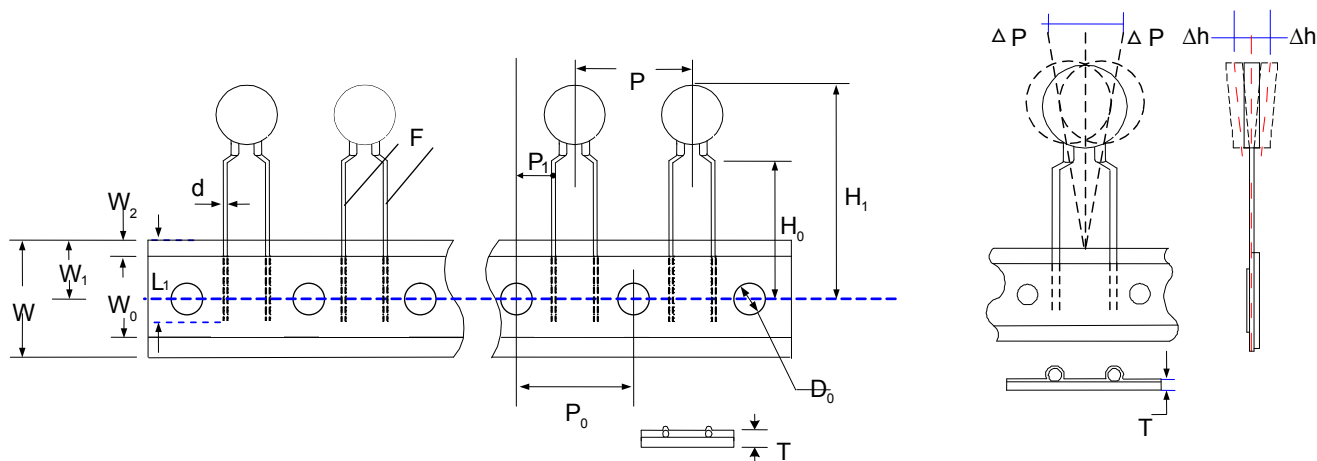

Taping Dimension	P ₀	F	P	P ₁	H ₀	H ₁	d	W ₀	W ₁	W ₂	W	Δ P	Δ h	L ₁	D ₀	T
	±0.3	±0.5	±1	±0.7	±0.5	Max.	±0.02	±1	+0.75 /-0.5	Max.	+1/ -0.5	Max.	Max.	Min.	±0.2	±0.2
P ₀ :12.7	12.7	5.0	12.7	3.85	16	28	0.5	12	9	3	18	1	2	9	4	0.6
P ₀ :15.0	15.0	5.0	15.0	5.00	16	28	0.5	12	9	3	18	1	2	9	4	0.6

NTC Thermistor : TTC05 Series



Φ5 mm Lead Type for Temperature Sensing/Compensation

■ Quantity

● Bulk Packing

Series	Standard Lead Type Quantity (pcs/bag)	Cut Lead Type Quantity (pcs/bag)
TTC05	250	500

● Reel Packing:

Series	D (mm)	D1 (mm)	W (mm)	Quantity (pcs/reel)
TTC05	340±10	31±1	46±1	2,500

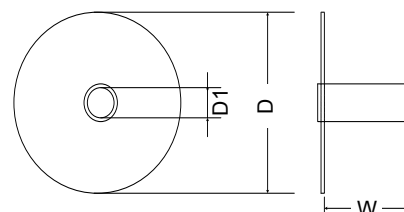

● Ammo Packing:

Series	Quantity (pcs/box)
TTC05	2,000

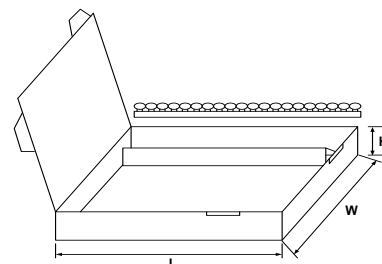

L	W	H
345mm	275mm	55mm

■ Warehouse Storage Conditions of Products

● Storage Conditions:

1. Storage Temperature: -10°C~+40°C
2. Relative Humidity: ≤75%RH
3. Keep away from corrosive atmosphere and sunlight.

● Period of Storage: 1 year